

SAFETY LOCKOUT

Product Catalogue

Quality products and services

SAFETY PRODUCT SAMPLE BOOK

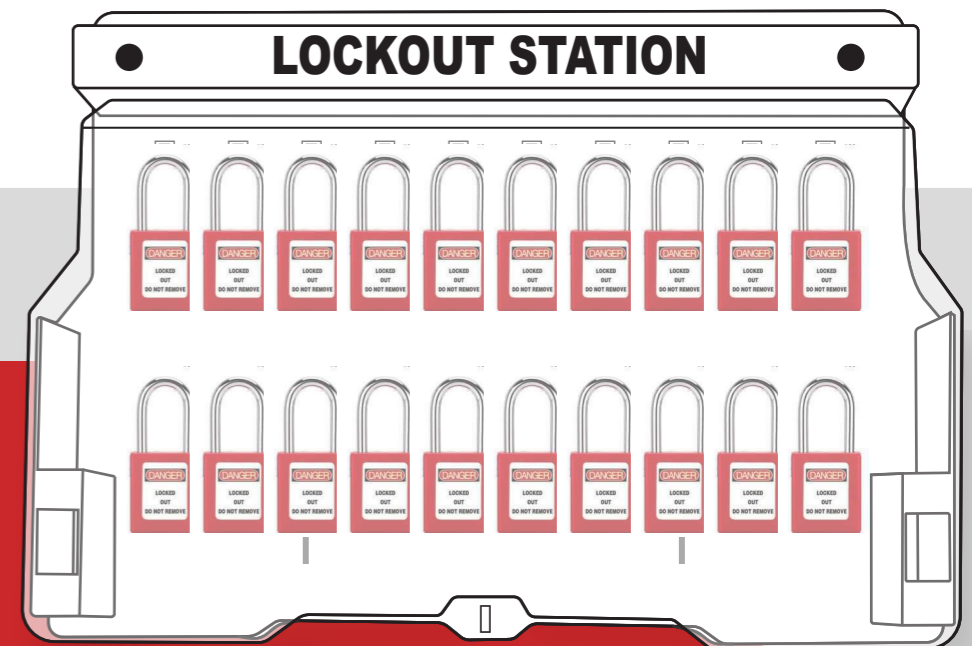

Dino Safety Product Co.,Ltd.

96/175Moo 6, Laharn, Bangbuathong Nonthaburi 11110, Thailand

Email: admin@dinosafety.asia



Patent



CE



ISO



ANSI



DIRECTORY

1



The Functions and Ways of Using the Key 03—05

2



Safety padlock 06—30

3



PVC Tag and Warning Sign 31—45

4



Electrical Lockout 46—65

5



Valve Lockout 66—76

6



Hasp Lockout 77—85

7



Cable Lockout 86—95

8



Lockout station 96—109

9



Floor Marking Tape Dispenser 110—111

10



Disposable Steel Wire Lock 112—113

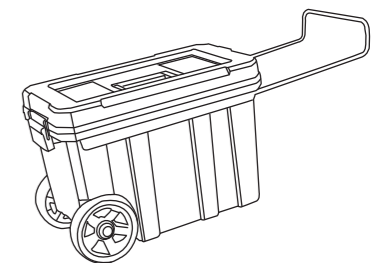

Lockout/Tagout Procedures:

1. Prepare for shutdown.

Identify the type of energy (power, machinery...) and potential hazards, locate the isolation devices and prepare to turn off the energy source.

2. Notification

Inform the relevant operators and supervisors who may be affected by isolating the machine.

3. Shut down

Shut down the machine or equipment.

4. Isolate the machine or equipment

Under necessary conditions, set isolation area for the machine or equipment which need Lockout/Tagout, such as warning tape, safety fence to isolate.

5. Lockout/Tagout

Apply Lockout/Tagout for hazardous power source.

6. Release hazardous energy

Release stocked hazardous energy, such as stocked gas, liquid. (Note: This step can operate before step 5, as per the actual situation to confirm.)

7. Verify

After Lockout/Tagout, verify the isolation of the machine or equipment is valid.

Remove Lockout/Tagout Procedures:



1 The Functions and Ways of Using the Key



Keyed to Differ

Each padlock has unique key, padlock cannot open mutually.

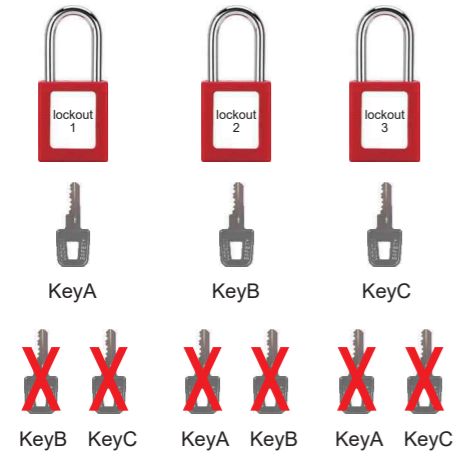

Keyed Alike

Within a group, all padlocks can open mutually, one key or several keys can open all padlocks in this group. Can customize several groups, between groups cannot open mutually.

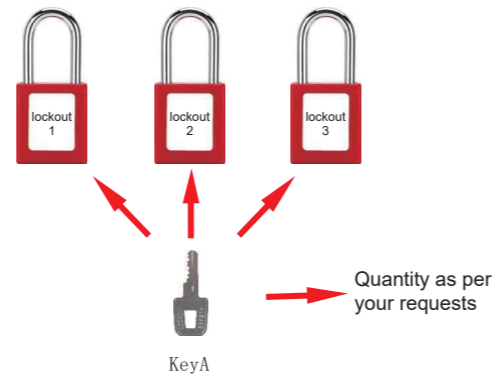

Grad Master Differ

Based on several groups of master&differ series, if you need to designate a higher-level supervisor key to open all groups, you can add third-level master keys.

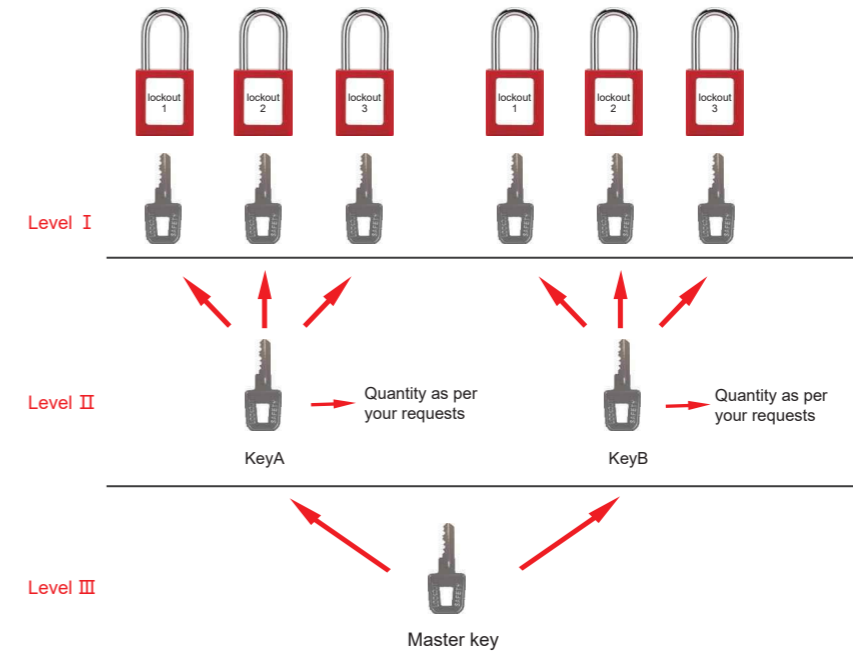

Master&Differ

Within a group, each padlock just has unique key, padlock cannot open mutually, but one master key can open all padlocks in the group. Can customize several groups, different master keys between groups cannot open mutually.

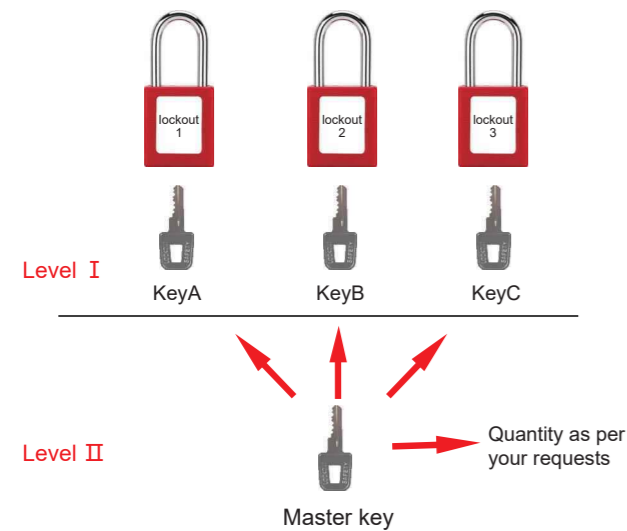

Master&Alike

Within a group, all padlocks can open mutually, one key or several keys can open all padlocks in this group. Can customize several groups, between groups cannot open mutually. And if need open all groups padlocks, can add a master key.

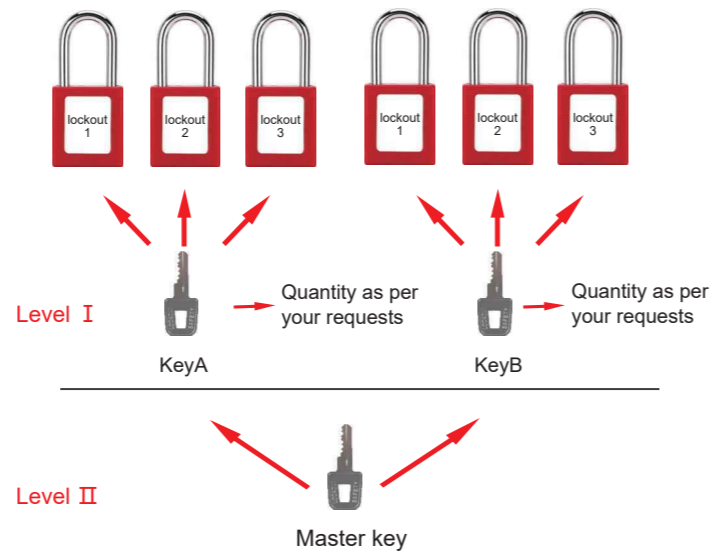

The Function and Ways of the Colors of the Key

The company can provide key shells of 16 different colors to collocate keys, making the functions of keys more powerful.

1. For example, the supervisor's key covers black shell and the personal key without shell, so that when it is used, it can easily distinguish which is the supervisor key.
2. Different departments use different colors key. For example, the electrical maintenance department uses a key with a red shell with a red padlock, the locksmith department uses a key with a yellow shell with a yellow padlock, and the production department uses a key with a blue shell with a blue padlock. In this way, the color can distinguish which department is overhauling or which department's key, which facilitates the key management.

The company can backup and archive the customer's padlock key according to the customer's request, so that the customer's key management system will be supplemented in the future which also can avoid the confusion of the original key management system.



2 Safety padlock

ABS Safety padlock

Padlock Function

16 colors ABS lock body



Lock core characteristics

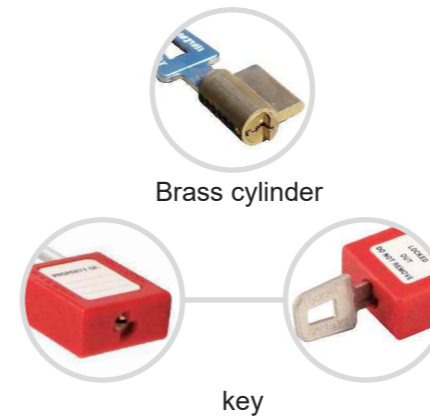

Can customize lock label



Shackle style

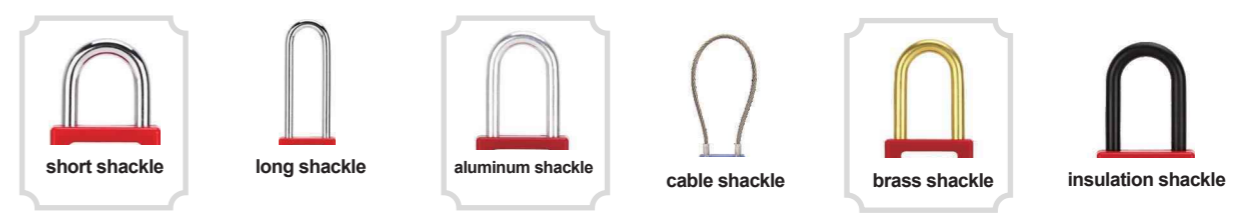

Print code by laser



Safety Padlock

BD-8511

- ABS lock body is resistant impact, UV, high and low temperature, shackle is steel chrome plated, hard and beautiful.
- Lock body dimensions: Length 45mm, Width 40mm, Thickness 19mm; Shackle Diameter 6mm, Shackle Height 25mm;
- Include 2 sets lock body warning labels, can write owner's information.
- 16 colors ABS lock body, convenient to choose.

Model	Description	Shackle Height
BD-8511	Keyed to differ, key-retaining	25mm
BD-8512	Keyed alike, key-retaining	
BD-8513	Master&alike, key-retaining	
BD-8514	Master&differ, key-retaining	

BD-8521

- ABS lock body is resistant impact, UV, high and low temperature, shackle is steel chrome plated, hard and beautiful.
- Lock body dimensions: Length 45mm, Width 40mm, Thickness 19mm; Shackle Diameter 6mm, Shackle Height 38mm;
- Include 2 sets lock body warning labels, can write owner's information.
- 16 colors ABS lock body, convenient to choose.

Model	Description	Shackle Height
BD-8521	Keyed to differ, key-retaining	38mm
BD-8522	Keyed alike, key-retaining	
BD-8523	Master&alike, key-retaining	
BD-8524	Master&differ, key-retaining	

BD-8525

- ABS lock body is resistant impact, UV, high and low temperature, shackle is steel chrome plated, hard and beautiful.
- Lock body dimensions: Length 45mm, Width 40mm, Thickness 19mm; Shackle Diameter 6mm, Shackle Height 76mm;
- Include 2 sets lock body warning labels, can write owner's information.
- 16 colors ABS lock body, convenient to choose.

Model	Description	Shackle Height
BD-8525	Keyed to differ, key-retaining	76mm
BD-8526	Keyed alike, key-retaining	
BD-8527	Master&alike, key-retaining	
BD-8528	Master&differ, key-retaining	

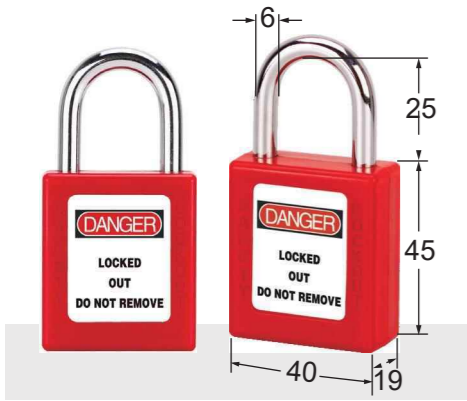

Insulation Safety Padlock

BD-8531

- Nylon lock body and nylon shackle combined perfectly, with better non-conductive, anti-magnetism, explosion-proof quality.
- Nylon shackle is non-conductive, especially suitable for chemical industry, military, mining, power and flammable and explosive areas.
- Lock body dimensions: Length 45mm, Width 40mm, Thickness 19mm; Shackle Diameter 6mm, Shackle Height 38mm.
- All fittings of padlock are explosion-proof, anti-magnetism, insulation.
- Include 2 sets lock body warning labels, can write owner's information.

Model	Description	Shackle Height
BD-8531	Keyed to differ, key-retaining	38mm
BD-8532	Keyed alike, key-retaining	
BD-8533	Master&alike, key-retaining	
BD-8534	Master&differ, key-retaining	



BD-8535

- Nylon lock body and nylon shackle combined perfectly, with better non-conductive, anti-magnetism, explosion-proof quality.
- Nylon shackle is non-conductive, especially suitable for chemical industry, military, mining, power and flammable and explosive areas.
- Lock body dimensions: Length 45mm, Width 40mm, Thickness 19mm; Shackle Diameter 6mm, Shackle Height 76mm.
- All fittings of padlock are explosion-proof, anti-magnetism, insulation.
- Include 2 sets lock body warning labels, can write owner's information.

Model	Description	Shackle Height
BD-8535	Keyed to differ, key-retaining	76mm
BD-8536	Keyed alike, key-retaining	
BD-8537	Master&alike, key-retaining	
BD-8538	Master&differ, key-retaining	



Spark-proof Aluminum Shackle Safety Padlock

BD-8541

- ABS lock body is resistant impact, UV, high and low temperature.
- Spark-proof aluminum shackle, anti-static, anti-magnetism, explosion-proof, corrosion-resistant.
- Lock body dimensions: Length 45mm, Width 40mm, Thickness 19mm; Shackle Diameter 6mm, Shackle Height 38mm.
- Include 2 sets lock body warning labels, can write owner's information.
- 16 colors ABS lock body, convenient to choose.

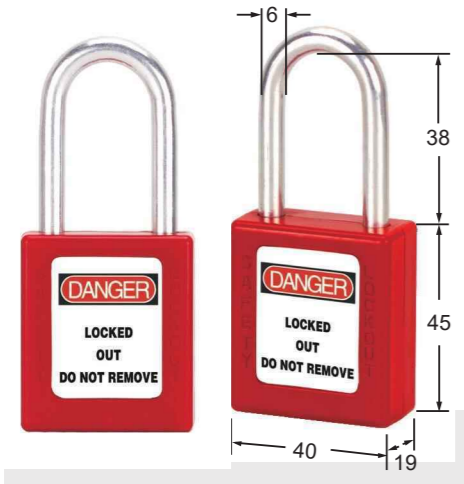

Model	Description	Shackle Material
BD-8541	Keyed to differ, key-retaining	Spark-proof aluminum
BD-8542	Keyed alike, key-retaining	
BD-8543	Master&alike, key-retaining	
BD-8544	Master&differ, key-retaining	

Long Lock Body Safety Padlock

BD-8571

- ABS lock body is resistant impact, UV, high and low temperature.
- Lock body dimensions: Length 80mm, Width 40mm, Thickness 19mm. Shackle Diameter 6mm, Shackle Height 38mm
- Shackle is heavy steel chrome plated, hard and beautiful.
- Include 2 sets lock body warning labels, can write owner's information.
- 16 colors ABS lock body, convenient to choose.



Model	Description	Shackle Height
BD-8571	Keyed to differ, key-retaining	38mm
BD-8572	Keyed alike, key-retaining	
BD-8573	Master&alike, key-retaining	
BD-8574	Master&differ, key-retaining	

Brass Shackle Safety Padlock

BD-8551

- Lock body dimensions: Length 45mm, Width 40mm, Thickness 19mm; Shackle Diameter 6mm, Shackle Height 38mm.
- ABS lock body is resistant impact, UV, high and low temperature.
- Brass shackle, anti-static, anti-magnetism, explosion-proof.
- Include 2 sets lock body warning labels, can write owner's information.
- 16 colors ABS lock body, convenient to choose.

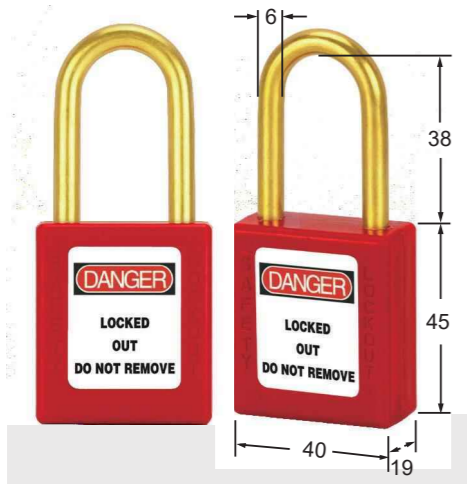

Model	Description	Shackle Material
BD-8551	Keyed to differ, key-retaining	Brass
BD-8552	Keyed alike, key-retaining	
BD-8553	Master&alike, key-retaining	
BD-8554	Master&differ, key-retaining	

BD-8575

- ABS lock body is resistant impact, UV, high and low temperature.
- Lock body dimensions: Length 80mm, Width 40mm, Thickness 19mm. Shackle Diameter 6mm, Shackle Height 76mm
- Shackle is heavy steel chrome plated, hard and beautiful.
- Include 2 sets lock body warning labels, can write owner's information.
- 16 colors ABS lock body, convenient to choose.



Model	Description	Shackle Height
BD-8575	Keyed to differ, key-retaining	76mm
BD-8576	Keyed alike, key-retaining	
BD-8577	Master&alike, key-retaining	
BD-8578	Master&differ, key-retaining	

Insulation Long Lock Body Safety Padlock

BD-8571N

- ABS lock body is resistant impact, UV, corrosion, high and low temperature.
- Lock body dimensions: Length 80mm, Width 40mm, Thickness 19mm, Shackle Diameter 6mm, Shackle Height 38mm.
- Nylon shackle is non-conductive, especially suitable for chemical industry, military, mining, power and flammable and explosive areas.
- Include 2 sets lock body warning labels, can write owner's information.
- 16 colors ABS lock body, convenient to choose.

Model	Description	Shackle Height
BD-8571N	Keyed to differ, key-retaining	38mm
BD-8572N	Keyed alike, key-retaining	
BD-8573N	Master&alike, key-retaining	
BD-8574N	Master&differ, key-retaining	

BD-8575N

- ABS lock body is resistant impact, UV, corrosion, high and low temperature.
- Lock body dimensions: Length 80mm, Width 40mm, Thickness 19mm, Shackle Diameter 6mm, Shackle Height 76mm.
- Nylon shackle is non-conductive, especially suitable for chemical industry, military, mining, power and flammable and explosive areas.
- Include 2 sets lock body warning labels, can write owner's information.
- 16 colors ABS lock body, convenient to choose.

Model	Description	Shackle Height
BD-8575N	Keyed to differ, key-retaining	76mm
BD-8576N	Keyed alike, key-retaining	
BD-8577N	Master&alike, key-retaining	
BD-8578N	Master&differ, key-retaining	



Dust-proof safety padlock function

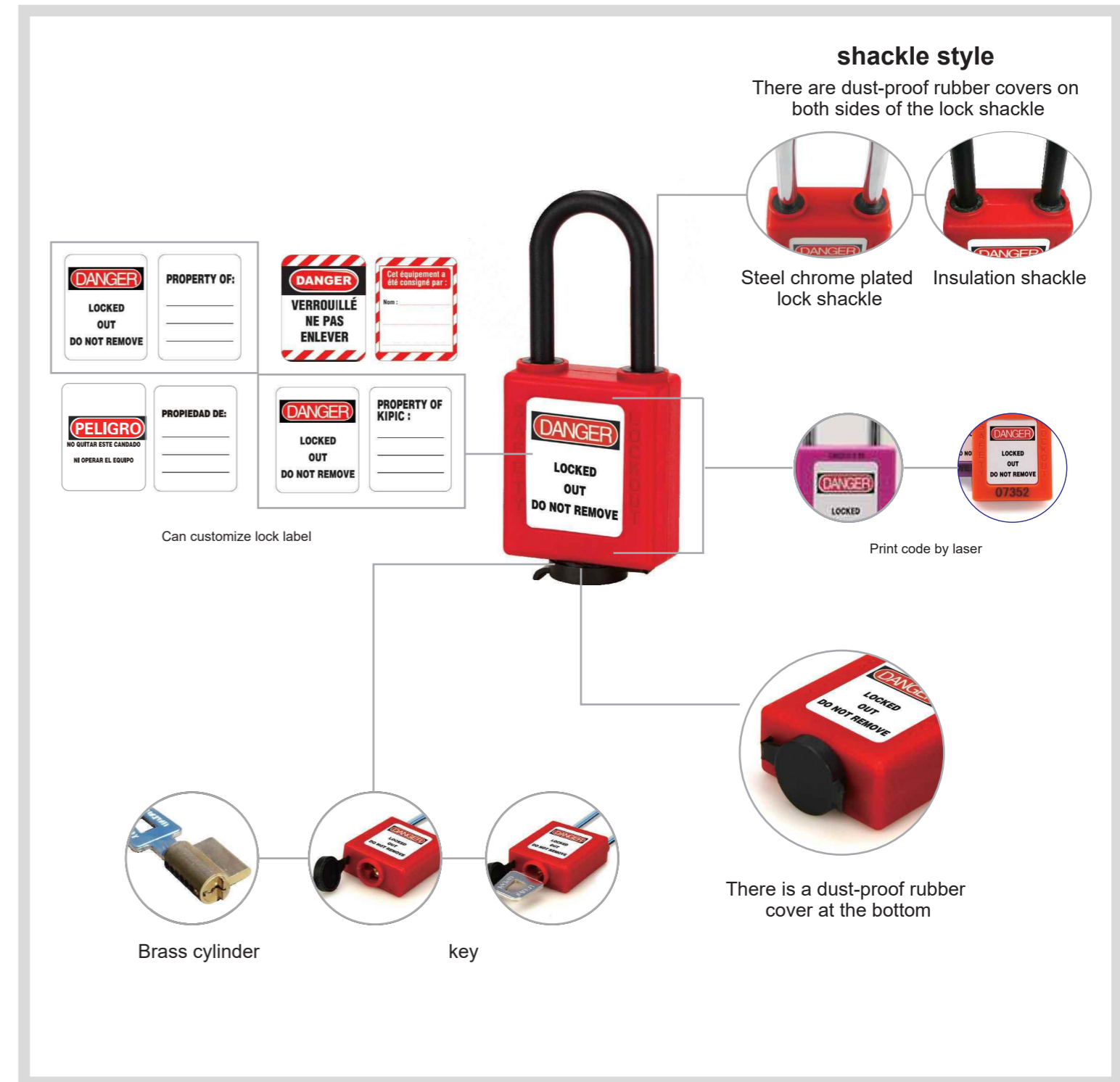



BD-8591

- ABS lock body is resistant impact, UV, high and low temperature.
- Lock body dimensions: Length 45mm, Width 40mm, Thickness 19mm, Shackle Diameter 6 mm, Shackle Height 38mm.
- Shackle is heavy steel chrome plated.
- The sealer to block keyhole is PP, soft and durable, good sealing.
- Include 2 sets lock body warning labels, can write owner's information.

Model	Description	Shackle Height
BD-8591	Keyed to differ, key-retaining	38mm
BD-8592	Keyed alike, key-retaining	
BD-8593	Master&alike, key-retaining	
BD-8594	Master&differ, key-retaining	



BD-8591N

- ABS lock body is resistant impact, UV, high and low temperature.
- Lock body dimensions: Length 45mm, Width 40mm, Thickness 19mm, shackle diameter 6 mm.
- Nylon shackle is non-conductive, especially suitable for chemical industry, military, mining, power and flammable and explosive areas.
- The sealer to block keyhole is PP, soft and durable, good sealing.
- Include 2 sets lock body warning labels, can write owner's information.

Model	Description	Shackle Height
BD-8591N	Keyed to differ, key-retaining	38mm
BD-8592N	Keyed alike, key-retaining	
BD-8593N	Master&alike, key-retaining	
BD-8594N	Master&differ, key-retaining	



BD-8595

- ABS lock body is resistant impact, UV, high and low temperature.
- Lock body dimensions: Length 45mm, Width 40mm, Thickness 19mm, Shackle Diameter 6 mm, Shackle Height 76mm.
- Shackle is heavy steel chrome plated.
- The sealer to block keyhole is PP, soft and durable, good sealing.
- Include 2 sets lock body warning labels, can write owner's information.

Model	Description	Shackle Height
BD-8595	Keyed to differ, key-retaining	76mm
BD-8596	Keyed alike, key-retaining	
BD-8597	Master&alike, key-retaining	
BD-8598	Master&differ, key-retaining	



BD-8595N

- ABS lock body is resistant impact, UV, high and low temperature.
- Lock body dimensions: Length 45mm, Width 40mm, Thickness 19mm, shackle diameter 6 mm.
- Nylon shackle is non-conductive, especially suitable for chemical industry, military, mining, power and flammable and explosive areas.
- The sealer to block keyhole is PP, soft and durable, good sealing.
- Include 2 sets lock body warning labels, can write owner's information.

Model	Description	Shackle Height
BD-8595N	Keyed to differ, key-retaining	76mm
BD-8596N	Keyed alike, key-retaining	
BD-8597N	Master&alike, key-retaining	
BD-8598N	Master&differ, key-retaining	

Stainless Steel Padlock



Laser Printing Positions

- Meticulous workmanship, 304 stainless steel material, beautiful, resistance corrosion and antirust.
- Double leakage holes to prevent water accumulation, corrosion.
- Arc edge design, grinding, good handle without cutting hands.
- Thicker lock body strong and firm high anti-theft performance.
- Thicker 304 stainless steel shackle can prevent cutting, sawing; safety and reliability.
- There are four specifications lock body to choose; each specification can collocate long shackle or short shackle.



BD-85A11



Model	Description	Height of Shackle	Size of Lock Body
BD-85A11	Keyed to differ, key-retaining	Clear height: 20mm Diameter: 5mm	Width: 30mm Height: 26mm Thickness: 12mm
BD-85A12	Keyed alike, key-retaining	Distance: 15mm	



BD-85A15



Model	Description	Height of Shackle	Size of Lock Body
BD-85A15	Keyed to differ, key-retaining	Clear height: 40mm Diameter: 5mm	Width: 30mm Height: 26mm Thickness: 16mm
BD-85A16	Keyed alike, key-retaining	Distance: 15mm	

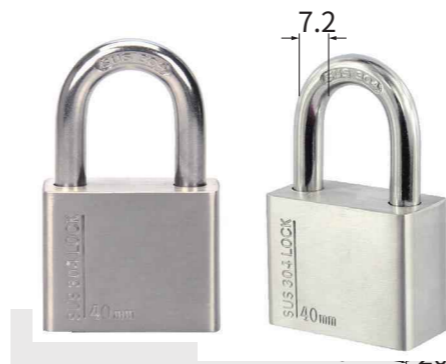

BD-85A21



Model	Description	Height of Shackle	Size of Lock Body
BD-85A21	Keyed to differ, key-retaining	Clear height: 26mm Diameter: 7.2mm	Width: 40mm Height: 32mm Thickness: 20mm
BD-85A22	Keyed alike, key-retaining	Distance: 20mm	



BD-85A25



Model	Description	Height of Shackle	Size of Lock Body
BD-85A25	Keyed to differ, key-retaining	Clear height: 45mm Diameter: 7.2mm	Width: 40mm Height: 32mm Thickness: 20mm
BD-85A26	Keyed alike, key-retaining	Distance: 20mm	



BD-85A41



Model	Description	Height of Shackle	Size of Lock Body
BD-85A41	Keyed to differ, key-retaining	Clear height: 35mm Diameter: 11mm	Width: 60mm Height: 42mm Thickness: 20mm
BD-85A42	Keyed alike, key-retaining	Distance: 28mm	



BD-85A31



Model	Description	Height of Shackle	Size of Lock Body
BD-85A31	Keyed to differ, key-retaining	Clear height: 30mm Diameter: 9mm	Width: 50mm Height: 38mm Thickness: 20mm
BD-85A32	Keyed alike, key-retaining	Distance: 23mm	



D-85A45



Model	Description	Height of Shackle	Size of Lock Body
BD-85A45	Keyed to differ, key-retaining	Clear height: 57mm Diameter: 11mm	Width: 60mm Height: 42mm Thickness: 20mm
BD-85A46	Keyed alike, key-retaining	Distance: 28mm	



D-85A35



Model	Description	Height of Shackle	Size of Lock Body
BD-85A35	Keyed to differ, key-retaining	Clear height: 55mm Diameter: 9mm	Width: 50mm Height: 38mm Thickness: 20mm
BD-85A36	Keyed alike, key-retaining	Distance: 23mm	

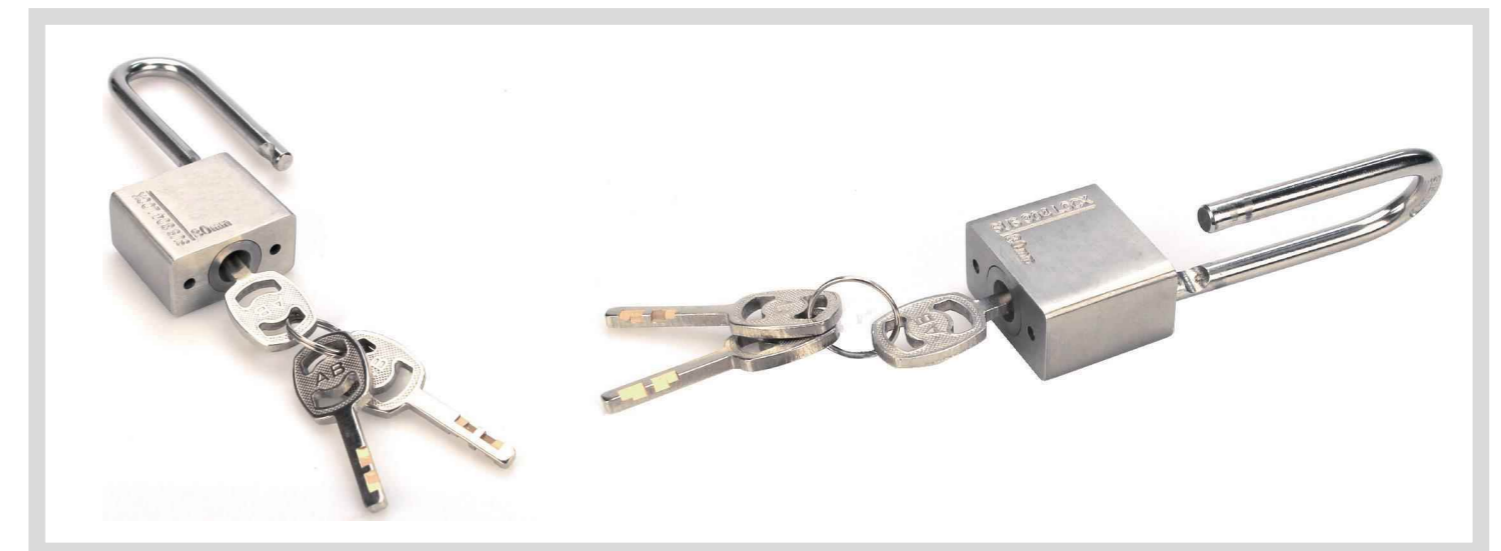

Aluminum Padlock



- Suitable for chemical, automobile industry etc., light and solid, resistant chemical corrosion, high and low temperature, UV, and impact.
- Arc lock body design, Aluminum lock body, Chromium plated steel shackle, light and solid, bear a strong external force.
- Brass cylinder is more resistant corrosion, 6 cartridge cylinder improve the anti-lock by others.
- Provided eight colourful mental which include red, yellow, green, blue, black, purple, white, and orange Differ cylinder lockout, it also customize by the user.
- The oxidized surface of the lock body is corrosion-resistant and can be labeled or laser engraved.

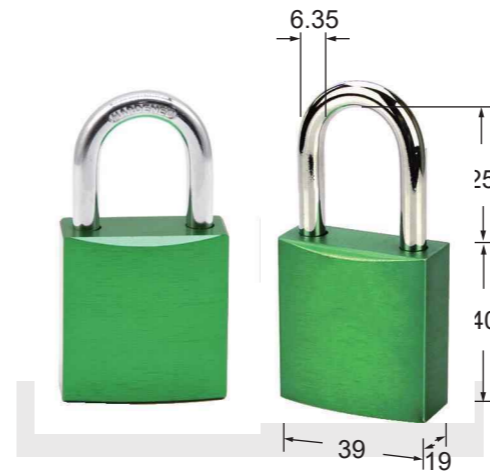

BD-85B01



Model	Description	Shackle Height
BD-85B01	Keyed to differ, key-retaining	25mm
BD-85B02	Keyed alike, key-retaining	
BD-85B03	Master&alike, key-retaining	
BD-85B04	Master&differ, key-retaining	

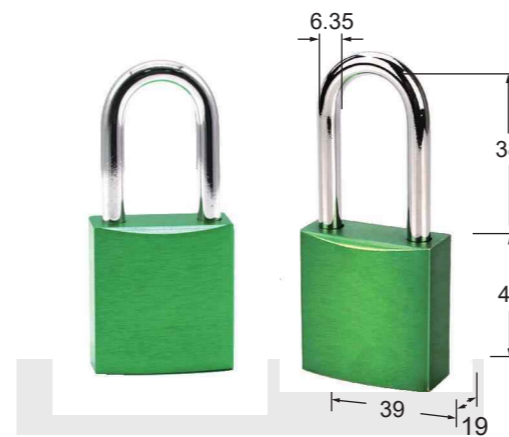

BD-85B11

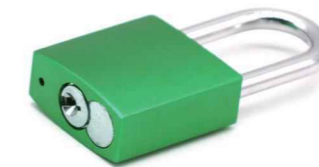

Model	Description	Shackle Height
BD-85B11	Keyed to differ, key-retaining	38mm
BD-85B12	Keyed alike, key-retaining	
BD-85B13	Master&alike, key-retaining	
BD-85B14	Master&differ, key-retaining	



BD-85B15

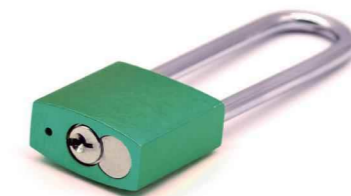

Model	Description	Shackle Height
BD-85B15	Keyed to differ, key-retaining	76mm
BD-85B16	Keyed alike, key-retaining	
BD-85B17	Master&alike, key-retaining	
BD-85B18	Master&differ, key-retaining	

Brass padlock

BD-85D11



- The lock body is made of brass material, strong and firm, strong anti-theft, meticulous and beautiful, and anti-corrosion.
 - The lock shackle is heavy steel chrome plated, which is strong and beautiful.
- There are two types of long shackle and short shackle to choose.

Model	Description	Shackle Height
BD-85D11	Keyed to differ, key-retaining	38mm
BD-85D12	Keyed alike, key-retaining	
BD-85D13	Master&alike, key-retaining	
BD-85D14	Master&differ, key-retaining	

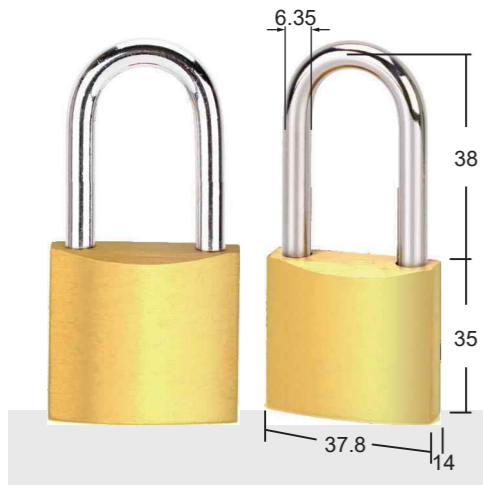

BD-85D21



- The lock body is made of brass material, strong and firm, strong anti-theft, meticulous and beautiful, and anti-corrosion.
 - The lock shackle is heavy steel chrome plated, which is strong and beautiful.
- There are two types of long shackle and short shackle to choose.

Model	Description	Shackle Height
BD-85D21	Keyed to differ, key-retaining	74.5mm
BD-85D22	Keyed alike, key-retaining	
BD-85D23	Master&alike, key-retaining	
BD-85D24	Master&differ, key-retaining	



Laminated Steel Safety Padlock

BD-8561



- Laminated padlock is suitable for using in special environment.
- Can stick obvious warning labels on lock body, easy to identify and manage.
- Lock body is made of laminated steel, shackle is steel chrome plated, hard and durable.
- Lock body dimensions: Length 36.2mm, Width 40mm, Thickness 23.5mm, Shackle Diameter 6mm, Shackle Height 27mm.
- The board on lock body for label is yellow, safe and eye-catching.

Model	Description	Shackle Height
BD-8561	Keyed to differ, key-retaining	27mm
BD-8561	Keyed alike, key-retaining	



BD-8565



- Laminated padlock is suitable for using in special environment.
- Can stick obvious warning labels on lock body, easy to identify and manage.
- Lock body is made of laminated steel, shackle is steel chrome plated, hard and durable.
- Lock body dimensions: Length 36.2mm, Width 40mm, Thickness 23.5mm, Shackle Diameter 6mm, Shackle Height 46mm.
- The board on lock body for label is yellow, safe and eye-catching.

Model	Description	Shackle Height
BD-8565	Keyed to differ, key-retaining	46mm
BD-8566	Keyed alike, key-retaining	



Stainless Steel Shackle Safety Padlock



BD-8581

- Nylon lock body is resistant impact, UV, high and low temperature.
- Shackle is made of 304 stainless steel, anti-acid, anti-alkali.
- Lock body dimensions: Length 45mm, Width 40mm, Thickness 19mm, Shackle Diameter 4mm, Shackle Height 38mm.
- Include 2 sets lock body warning labels, can write owner's information.

Model	Description	Shackle Height
BD-8581	Keyed to differ, key-retaining	38mm
BD-8582	Keyed alike, key-retaining	
BD-8583	Master&alike, key-retaining	
BD-8584	Master&differ, key-retaining	

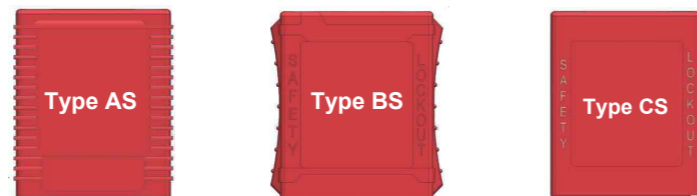

Three types of lock body are available to choose



Nylon Safety Padlock **NEW**

Padlock function

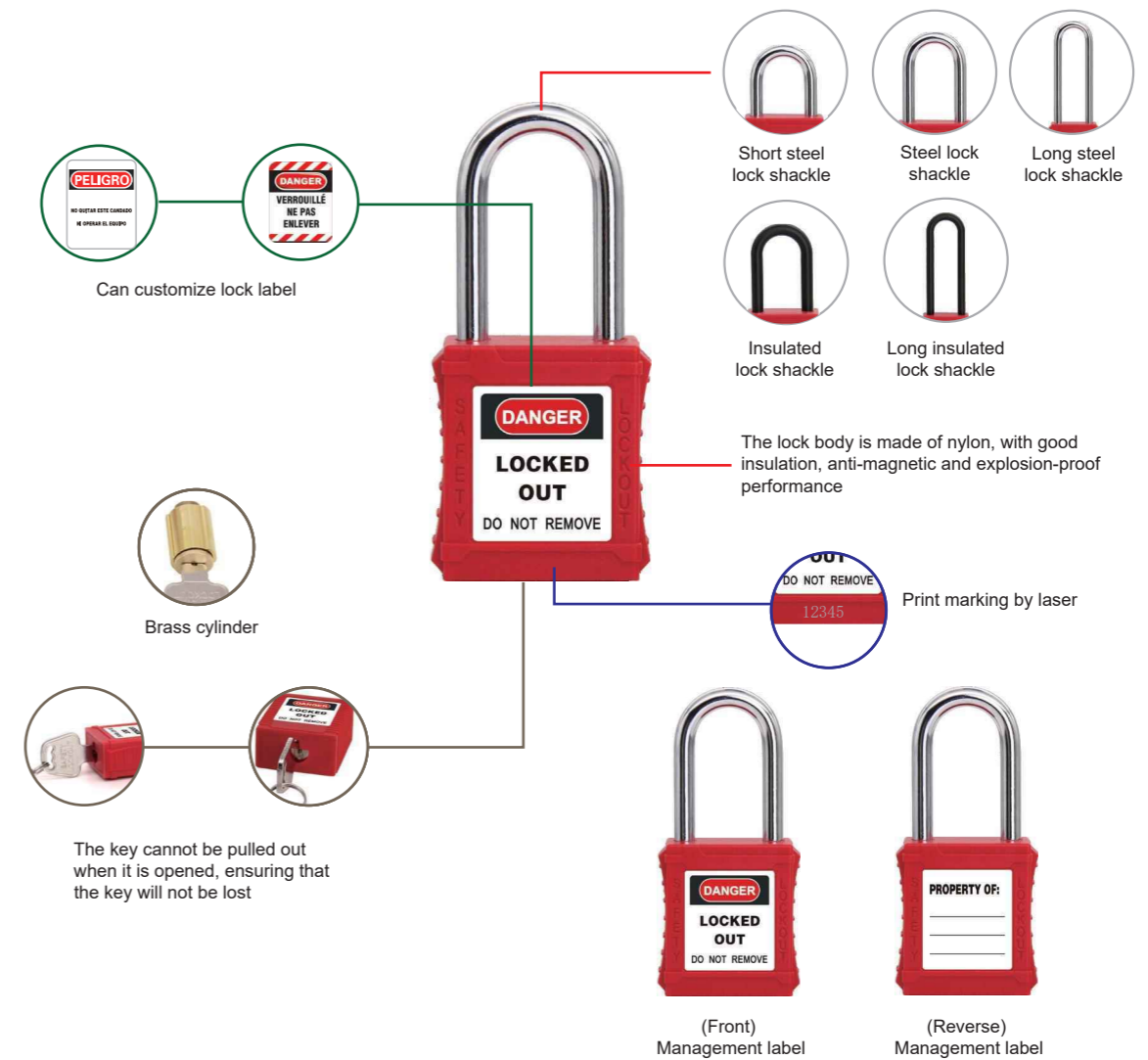

The following padlock body are available



Nylon Safety Padlock [BD-8511]



BD-8511AS

BD-8511BS

BD-8511CS

- Nylon lock body is resistant impact, UV, high and low temperature, shackle is heavy steel chrome plated, hard and beautiful.
- Lock body dimensions: Length 45mm, Width 40mm, Thickness 19mm; Shackle Diameter 6mm, Shackle Height 25mm.
- Include 2 sets lock body warning labels, can write owner's information.

Model	Description	Shackle Height	Lock body type
BD-8511AS/BS/CS	Keyed to differ, key-retaining	25mm	AS BS CS
BD-8512AS/BS/CS	Keyed alike, key-retaining		
BD-8513AS/BS/CS	Master&alike, key-retaining		
BD-8514AS/BS/CS	Master&differ, key-retaining		

Nylon Safety Padlock [BD-8521]



BD-8521AS

BD-8521BS

BD-8521CS

- Nylon lock body is resistant impact, UV, high and low temperature, shackle is heavy steel chrome plated, hard and beautiful.
- Lock body dimensions: Length 45mm, Width 40mm, Thickness 19mm; Shackle Diameter 6mm, Shackle Height 38mm.
- Include 2 sets lock body warning labels, can write owner's information.

Model	Description	Shackle Height	Lock body type
BD-8521AS/BS/CS	Keyed to differ, key-retaining	38mm	AS BS CS
BD-8522AS/BS/CS	Keyed alike, key-retaining		
BD-8523AS/BS/CS	Master&alike, key-retaining		
BD-8524AS/BS/CS	Master&differ, key-retaining		

Nylon Safety Padlock [BD-8525]



BD-8525AS

BD-8525BS

BD-8525CS

Nylon Safety Padlock [BD-8531]



BD-8531AS

BD-8531BS

BD-8531CS

- Nylon lock body is resistant impact, UV, high and low temperature, shackle is heavy steel chrome plated, hard and beautiful.
- Lock body dimensions: Length 45mm, Width 40mm, Thickness 19mm; Shackle Diameter 6mm, Shackle Height 76mm.
- Include 2 sets lock body warning labels, can write owner's information.

- Nylon lock body and nylon shackle combined perfectly, with better non-conductive, anti-magnetism, explosion-proof quality.
- Nylon shackle is non-conductive, especially suitable for chemical industry, military, mining, power and flammable and explosive areas.
- Lock body dimensions: Length 45mm, Width 40mm, Thickness 19mm; Shackle Diameter 6mm, Shackle Height 38mm.
- Shackle Height 38mm.
- All fittings of padlock are explosion-proof, anti-magnetism, insulation.
- Include 2 sets lock body warning labels, can write owner's information.

Model	Description	Shackle Height	Lock body type
BD-8525AS/BS/CS	Keyed to differ, key-retaining	76mm	AS BS CS
BD-8526AS/BS/CS	Keyed alike, key-retaining		
BD-8527AS/BS/CS	Master&alike, key-retaining		
BD-8528AS/BS/CS	Master&differ, key-retaining		

Model	Description	Shackle Height	Lock body type
BD-8531AS/BS/CS	Keyed to differ, key-retaining	38mm	AS BS CS
BD-8532AS/BS/CS	Keyed alike, key-retaining		
BD-8533AS/BS/CS	Master&alike, key-retaining		
BD-8534AS/BS/CS	Master&differ, key-retaining		

Nylon Safety Padlock [BD-8535]



BD-8535AS

BD-8535BS

BD-8535CS

- Nylon lock body and nylon shackle combined perfectly, with better non-conductive, anti-magnetism, explosion-proof quality.
- Nylon shackle is non-conductive, especially suitable for chemical industry, military, mining, power and flammable and explosive areas.
- Lock body dimensions: Length 45mm, Width 40mm, Thickness 19mm; Shackle Diameter 6mm, Shackle Height 76mm.
- All fittings of padlock are explosion-proof, anti-magnetism, insulation.
- Include 2 sets lock body warning labels, can write owner's information.

Model	Description	Shackle Height	Lock body type
BD-8535AS/BS/CS	Keyed to differ, key-retaining	76mm	AS BS CS
BD-856AS/BS/CS	Keyed alike, key-retaining		
BD-8537AS/BS/CS	Master&alike, key-retaining		
BD-8538AS/BS/CS	Master&differ, key-retaining		

3 PVC Tag and Warning Sign



PVC Tag [BD-8611]



- PVC material, sunscreen ink printing, suitable for outdoor.
- 10 pieces per bag.
- Can customize as per customers' request.

Regular Type



BD-8611 PVC Tags Length:145mm Width: 75mm

Thickness: 0.8mm Lockhole diameter: 8mm

Customize Type



PVC Tag [BD-8621]



- BD-8621 PVC Warning Signs Material: PVC Printing requests: dimensions and content can customize as per request
- Regular Size: 300mm X 200mm.
- BD-8622 Sticky Warning Signs Material: Sticky Printing requests: dimensions and content can customize as per request
- Regular Size: 300mm X 200mm.



Scaffolding Tag

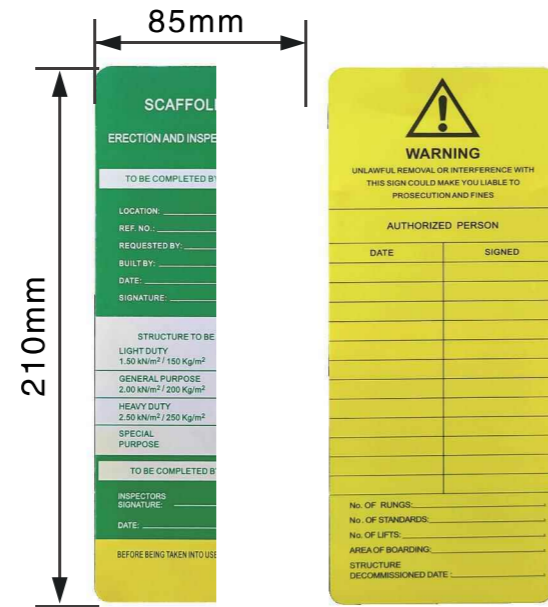

Insert Card

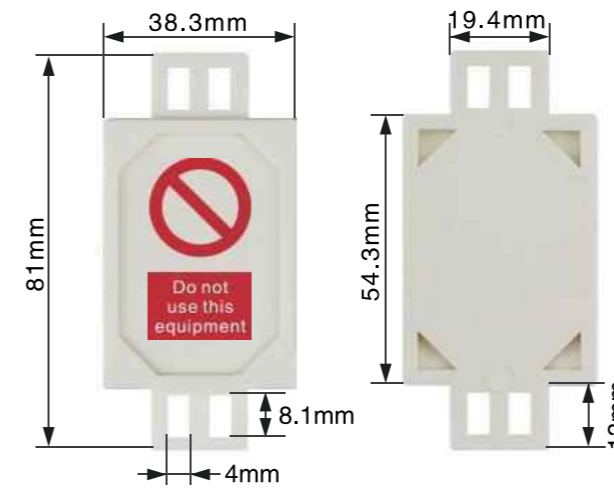

BD-831

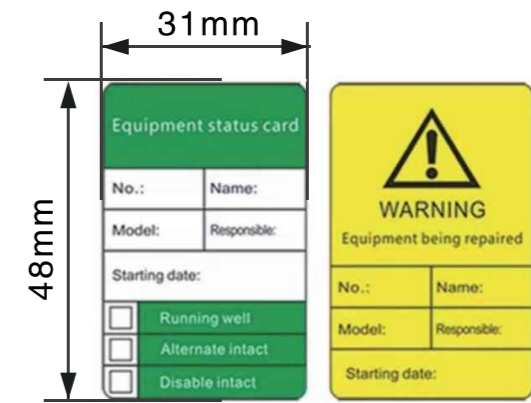

BD-831KZ

Category	Description
Scaffolding Tag	can be attached to equipment with adhesive or tied to electrical wire with cable ties, suitable for all legal hanging points
Insert Card	Green card: The scaffolding is safe and can be used normally; Yellow card: The scaffolding is under maintenance; Red card (no card inserted): Scaffolding is prohibited to use.



- Scaffolding tag, insert card customization service: can print customized content, such as customer information, company logo, contact number, etc.;
- Language: Chinese, English, Chinese and English, and other languages.
- One-piece tag slot
- Tag body is made of high-strength ABS engineering plastic, which is heat-resistant, cold-resistant, and corrosion-resistant;
- Available in multiple colors, it can be used by different departments.

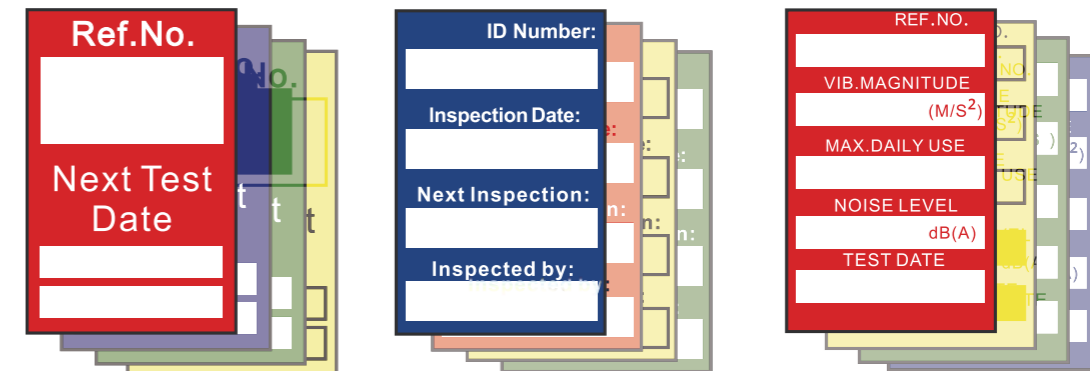

BD-831KZ Insert Card style





BD-832

BD-832KZ

Category	Description
Scaffolding Tag	can be attached to equipment with adhesive or tied to electrical wire with cable ties, suitable for all legal hanging points
Insert Card	Green card: The scaffolding is safe and can be used normally; Yellow card: The scaffolding is under maintenance; Red card (no card inserted): Scaffolding is prohibited to use.

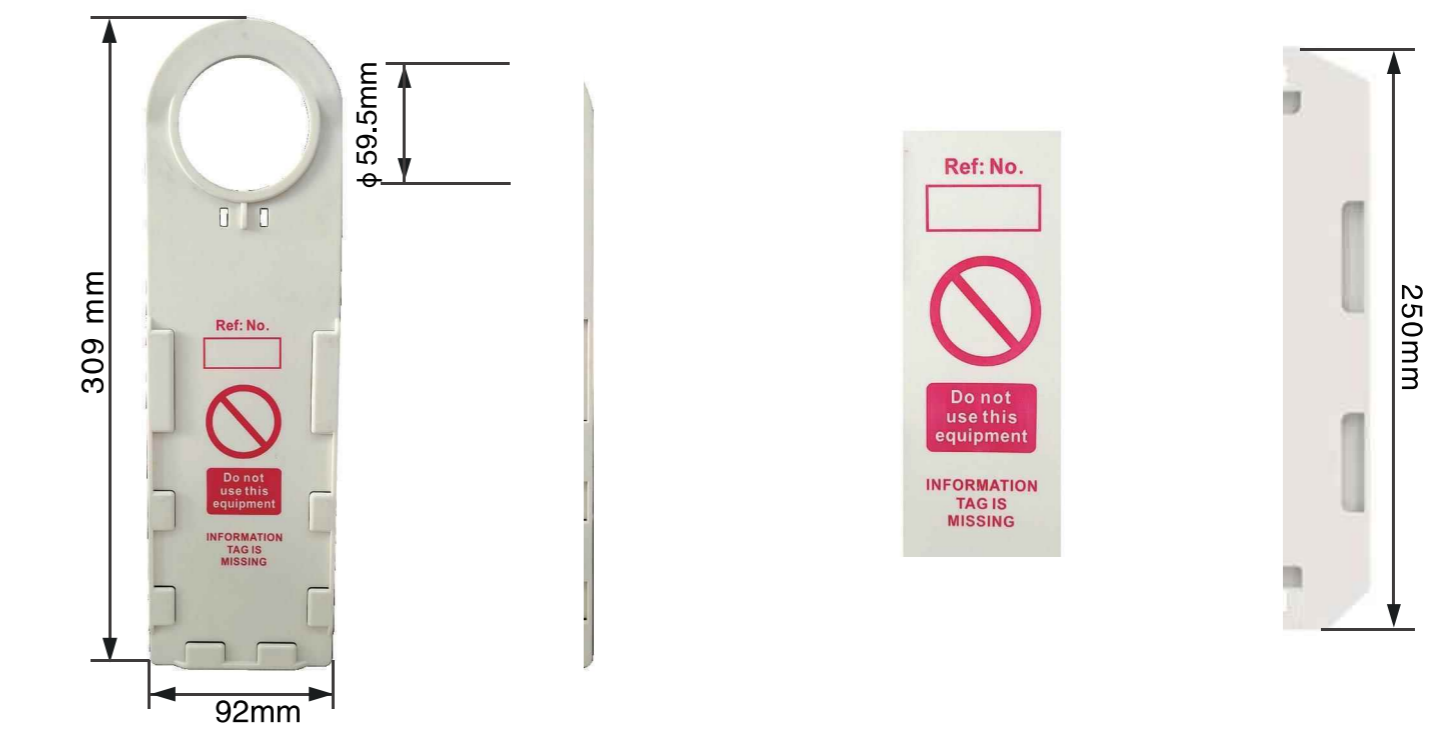

Insert Card style



Category	Description
Scaffolding Tag	can be attached to equipment with adhesive or tied to electrical wire with cable ties, suitable for all legal hanging points
Insert Card	Green card: The scaffolding is safe and can be used normally; Yellow card: The scaffolding is under maintenance; Red card (no card inserted): Scaffolding is prohibited to use.

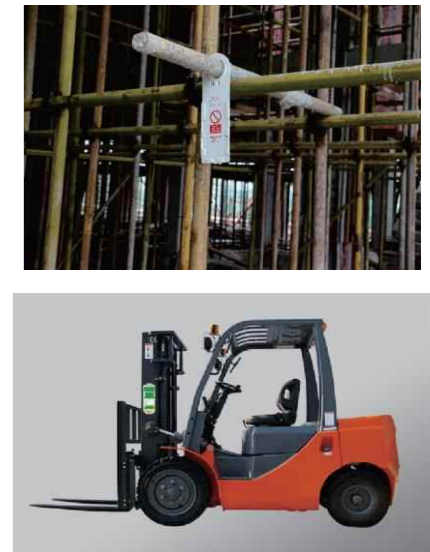

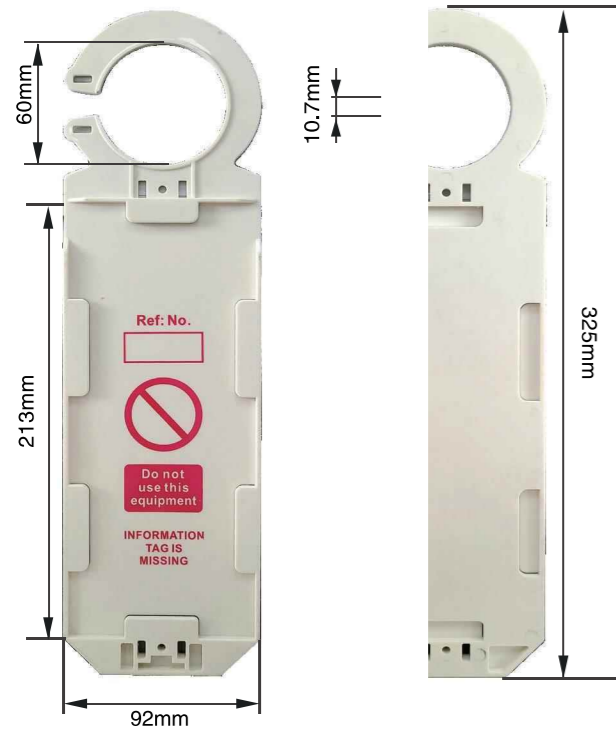

Category	Description
Scaffolding Tag	can be attached to equipment with adhesive or tied to electrical wire with cable ties, suitable for all legal hanging points
Insert Card	Green card: The scaffolding is safe and can be used normally; Yellow card: The scaffolding is under maintenance; Red card (no card inserted): Scaffolding is prohibited to use.



BD-836



BD-836KZ

Category	Description
Scaffolding Tag	can be attached to equipment with adhesive or tied to electrical wire with cable ties, suitable for all legal hanging points
Insert Card	Green card: The scaffolding is safe and can be used normally; Yellow card: The scaffolding is under maintenance; Red card (no card inserted): Scaffolding is prohibited to use.



Insert Card style



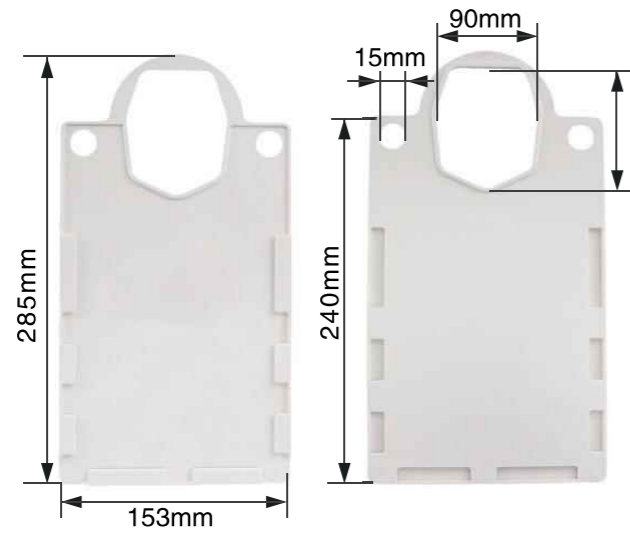

BD-837



BD-837KZ

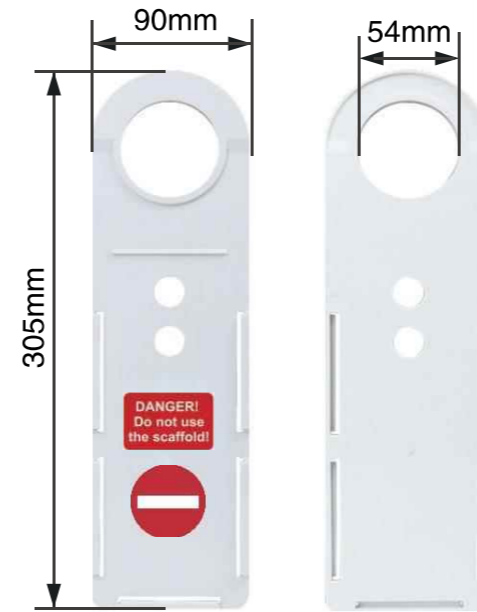

BD-838



KZ

Category	Description
Scaffolding Tag	can be attached to equipment with adhesive or tied to electrical wire with cable ties, suitable for all legal hanging points
Insert Card	Green card: The scaffolding is safe and can be used normally; Yellow card: The scaffolding is under maintenance; Red card (no card inserted): Scaffolding is prohibited to use.

Category	Description
Scaffolding Tag	can be attached to equipment with adhesive or tied to electrical wire with cable ties, suitable for all legal hanging points
Insert Card	Green card: The scaffolding is safe and can be used normally; Yellow card: The scaffolding is under maintenance; Red card (no card inserted): Scaffolding is prohibited to use.

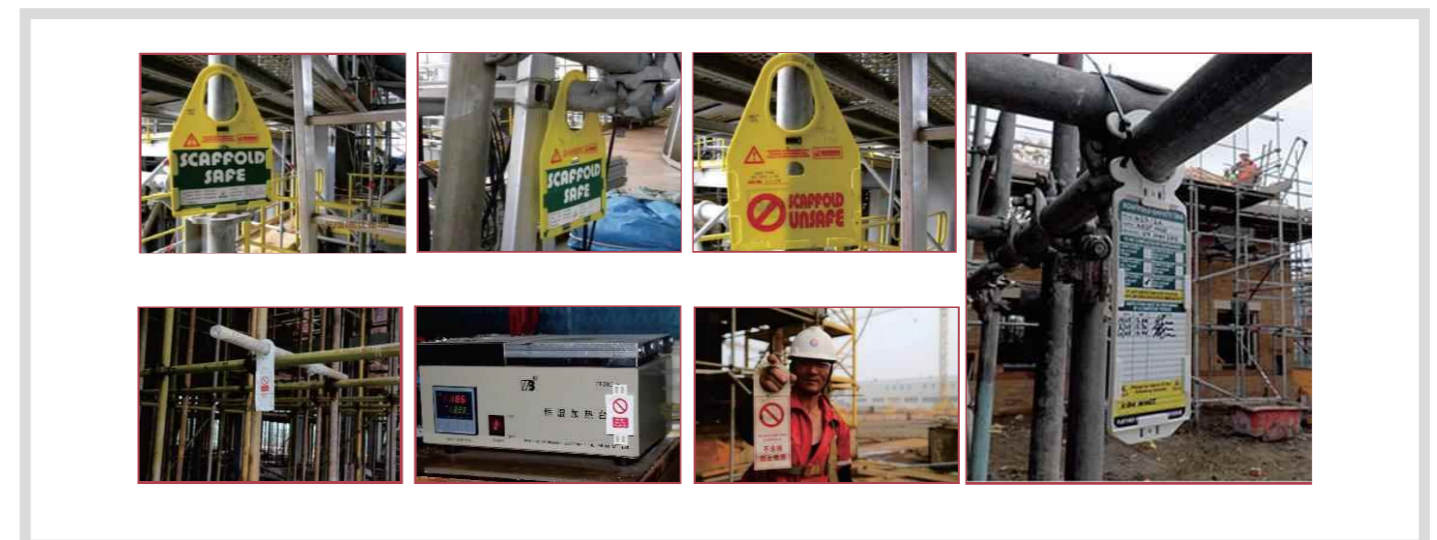

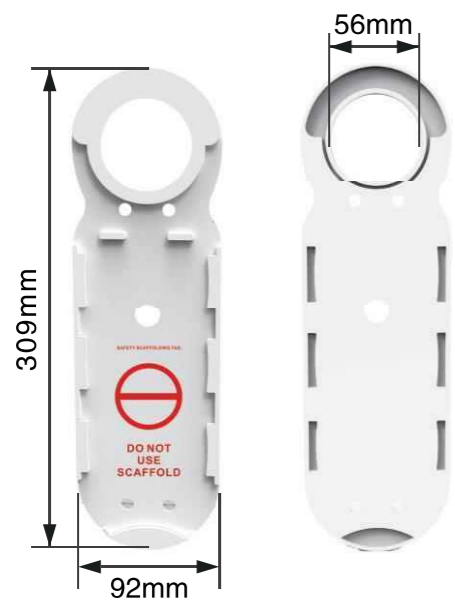

BD-839

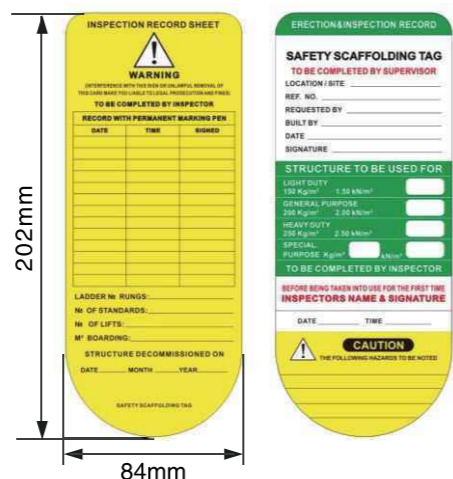

BD-838KZ

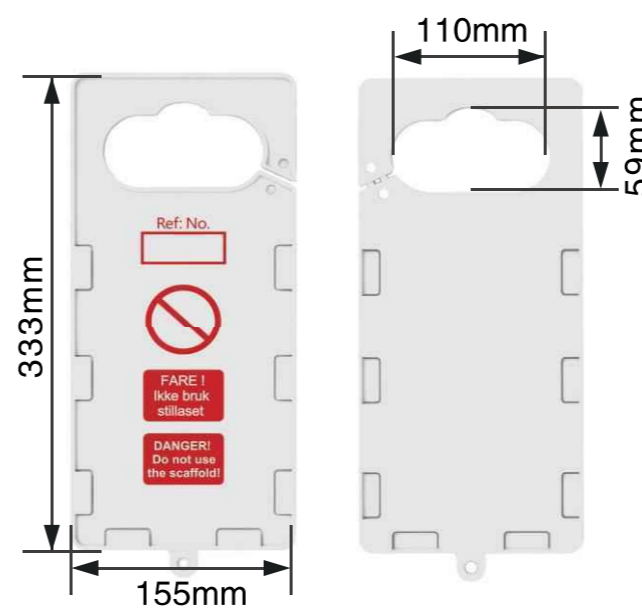

BD-840

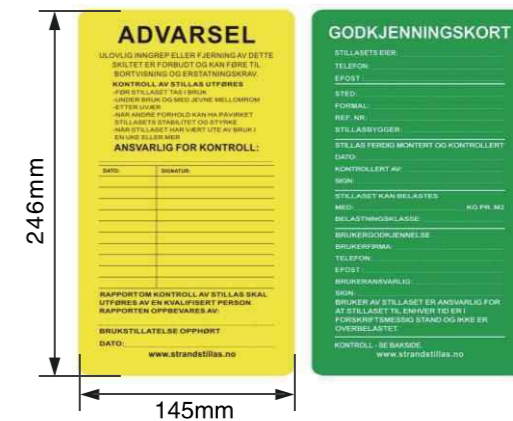

BD-840KZ

Category	Description
Scaffolding Tag	can be attached to equipment with adhesive or tied to electrical wire with cable ties, suitable for all legal hanging points
Insert Card	Green card: The scaffolding is safe and can be used normally; Yellow card: The scaffolding is under maintenance; Red card (no card inserted): Scaffolding is prohibited to use.

Category	Description
Scaffolding Tag	can be attached to equipment with adhesive or tied to electrical wire with cable ties, suitable for all legal hanging points
Insert Card	Green card: The scaffolding is safe and can be used normally; Yellow card: The scaffolding is under maintenance; Red card (no card inserted): Scaffolding is prohibited to use.



4 Electrical Lockout



Industrial Electrical Lockout

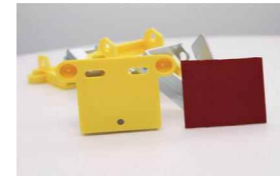

Back glue 5cm × 5cm



Magnetic suction
Note: +C after the model

BD-8101~8107

- The lock body is made of alloy engineering plastic and A3 galvanized steel plate;
- It can lock a variety of non-standard electrical or distribution cabinets.
- Two fixed methods (back glue 5cm × 5cm, magnetic suction)
- Base: width 54mm × 51mm (general parts)

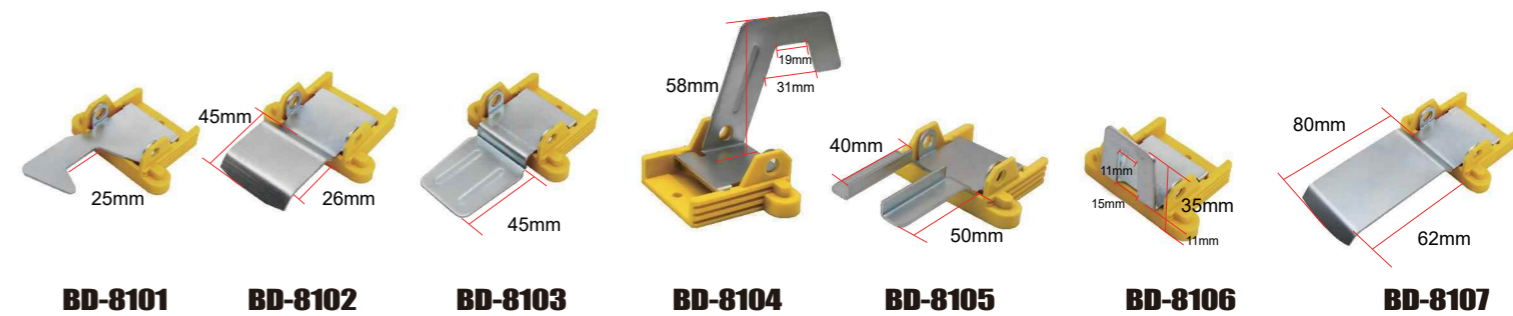

BD-8101

BD-8102

BD-8103

BD-8104

BD-8105

BD-8106

BD-8107

Model	Description
BD-8101	With back glue, suitable for locking knob switch, changeover switch, etc
BD-8102	With back glue, suitable for locking button switch, lock hole of distribution cabinet, etc
BD-8103	With back glue, suitable for locking cabinet door, electrical handle hole, low voltage drawer cabinet, etc
BD-8104	With back glue, suitable for locking drawer cabinet switch handle and changeover switch
BD-8105	With back glue, suitable for locking knife switch, handle switch, etc
BD-8106	With back glue, suitable for locking knob switch, changeover switch, etc
BD-8107	With back glue, suitable for locking knob switch, lock hole of distribution cabinet, etc
BD-8101C	With magnetic suction, suitable for locking knob switch, changeover switch, etc
BD-8102C	With magnetic suction, suitable for locking button switch, lock hole of distribution cabinet, etc
BD-8103C	With magnetic suction, suitable for locking cabinet door, electrical handle hole, low voltage drawer cabinet, etc
BD-8104C	With magnetic suction, suitable for locking drawer cabinet switch handle and changeover switch
BD-8105C	With magnetic suction, suitable for locking knife switch, handle switch, etc
BD-8106C	With magnetic suction, suitable for locking knob switch, changeover switch, etc
BD-8107C	With magnetic suction, suitable for locking knob switch, lock hole of distribution cabinet, etc



Miniature Circuit Breaker Lockout

- Be made of ABS resin and has good insulation performance.
- Pin out (in) with a unique design, easy to install.
- Can customize to mark on lockout by laser.
- Use with professional safety padlock and tag together.

BD-8111



Description

Pin out, suitable for the circuit breaker toggle switch width ≤ 12mm, ABS material

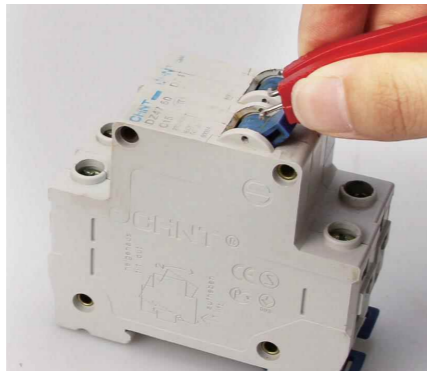

BD-8112



Description

Pin out, suitable for the circuit breaker toggle switch width ≤ 20mm, ABS material

BD-8114



Description

Pin in, suitable for locking space maximum 12.7mm, ABS material



BD-8120

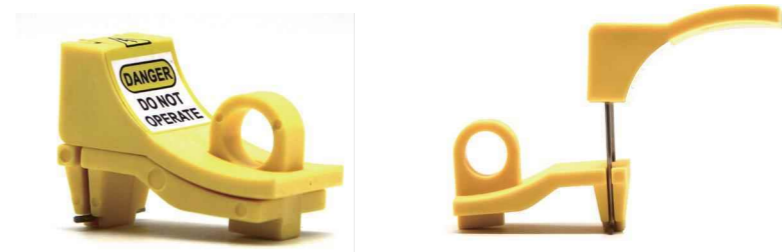

Description

suitable for Miniature Circuit Breaker

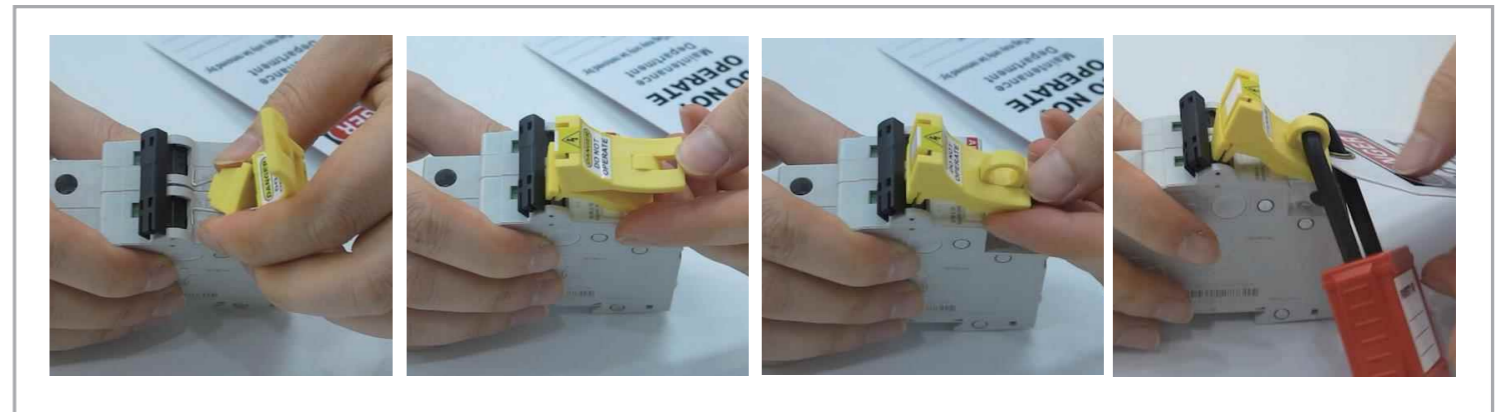

Multi-mini Breaker Lockout

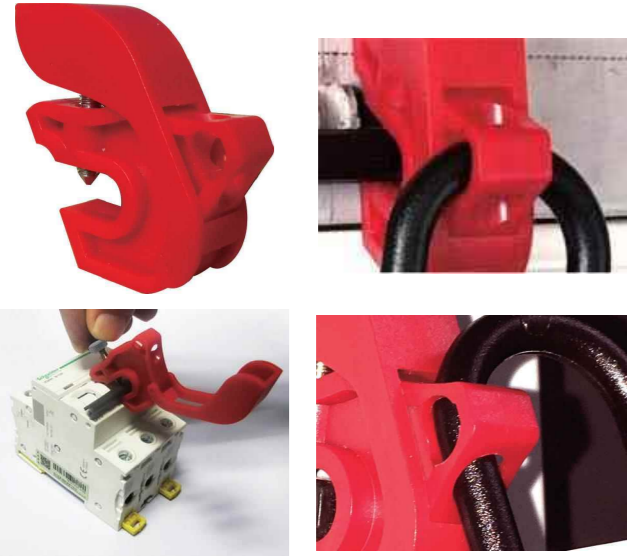

BD-8113

- Be made of ABS and miniature brass screw with nickel plated.
- External dimensions: Length 58mm, Width 42mm, Thickness 14.5mm.
- With a screw can tighten directly to install, easy to use, without assistant tools.
- Can customize to mark on lockout by laser.
- Use with professional safety padlock and tag together, padlock can be horizontal or vertical locked in two methods.

Description

Suitable for the circuit breaker toggle switch thickness maximum 9mm, no limit for width.



Motor Circuit Breaker Lockout



BD-8118

- Be made of ABS and brass screw with nickel plated.
- With a screw can tighten to install, easy to use, without assistant tools.
- Special square hole slot and screw can guarantee not appear any swing after be locked.
- Can customize to mark on lockout by laser.
- Use with professional safety padlock and tag together.

Description

Suitable for motor circuit breaker (button dimensions ≤ 14.5mm X 22mm)



suitable this kind of circuit breaker

Step 1



Step 2

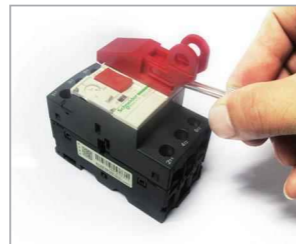

Step 3



BD-8119A

- Be made of high strength nylon(PA) plastic;
- Safely and effectively lock miniature circuit breaker, suitable for European and Asian equipment;
- Available for single-pole and multi-pole circuit breakers;
- Recommend to use with safety padlock with maximum 7mm diameter shackle;
- No extra tool needed, can be install easily with a rod, button or screw.

Description

Suitable for multi-pole miniature circuit breaker

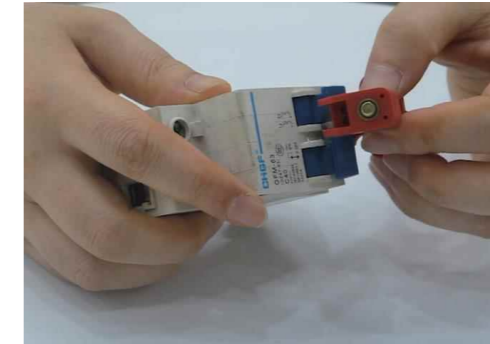
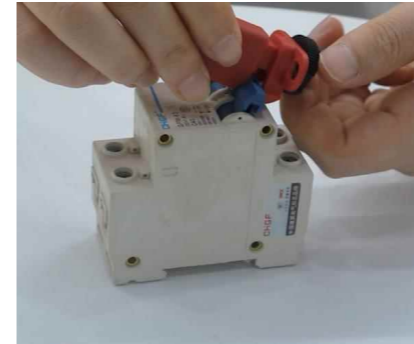

BD-8119

- Be made of Nylon&ABS lock body
- With a screw can tighten to install, easy to use, without assistant tools.
- Wide application: suitable for various miniature circuit breakers (handle widths ≤ 15mm)



Description

7mm ≤ a ≤ 15mm miniature circuit breaker

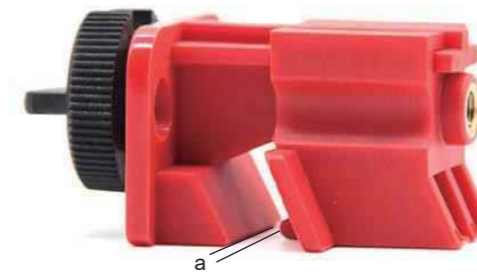

suitable this kind of circuit breaker

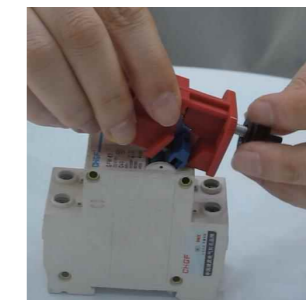

Motor Circuit Breaker Lockout



BD-8121

- Be made of ABS and brass screw with nickel plated.
- With a screw can tighten to install, easy to use, without ass
- Special square hole slot and screw can guarantee not appear any swing after be locked.
- Can customize to mark on lockout by laser.
- Use with professional safety padlock and tag together.

Description

Suitable for miniature circuit breaker (handle width≤17mm, handle thickness≤15mm)



Step 1



suitable this kind of circuit breaker

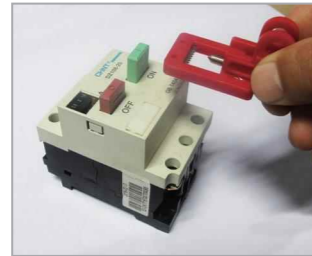

Step 2

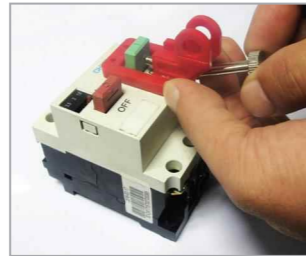

Step 3



Moulded Case Circuit Breaker Lockout



BD-8122

- Be made of ABS and brass screw with nickel plated.
- With a screw can tighten to install, easy to use, without assistant tools.
- Can customize to mark on lockout by laser.
- Use with professional safety padlock and tag together.

Description

Suitable for all kinds of medium-sized circuit breaker (handle thickness: 11mm-18mm, no limit to width).



suitable this kind of circuit breaker

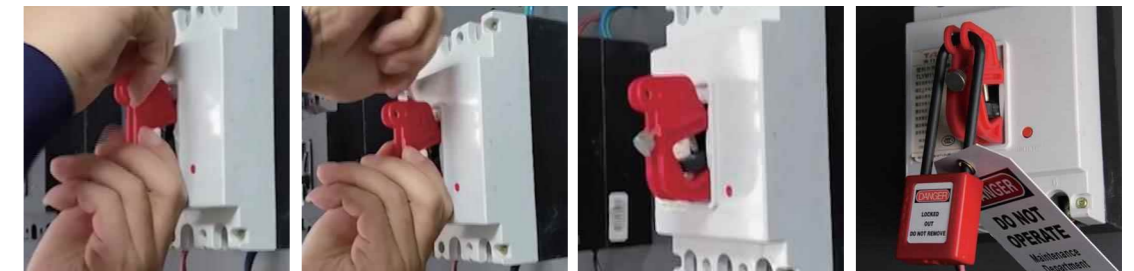

Moulded Case Circuit Breaker Lockout(small)



BD-8121A

- Be made of ABS resin and has good insulation performance.
- Special stainless steel teeth design, fixed by screw, providing better bite for handle.
- According to the circuit breaker handle space, the adjustable baffle can move to confirm the suitable position.
- Can customize to mark on lockout by laser.
- Use with professional safety padlock and tag together.

Description

Suitable for handle width≤19.5mm, thickness≤10mm



suitable this kind of circuit breaker



BD-8122A

- Be made of ABS resin and has good insulation performance.
- Special stainless steel teeth design, fixed by screw, providing better bite for handle.
- Can customize to mark on lockout by laser.
- Use with professional safety padlock and tag together.

Description

Suitable for handle width≤41mm, thickness≤15.8mm



suitable this kind of circuit breaker



Simple Circuit Breaker Lockout



BD-8123A



23C



BD-8123D



D-8123F

BD-8123A~F

- Be made of ABS.
- Can be locked with a screw driver.
- Can accommodate one safety padlock with shackle diameter $\leq 7\text{mm}$.
- Can customize to mark on lockout by laser.
- Use with professional safety padlock and tag together.

suitable this kind of circuit breaker



Model	Description
BD-8123A	Suitable for single pole miniature circuit breakers with handle thickness $< 7.7\text{mm}$.
BD-8123B	Suitable for 2 to 4 poles miniature circuit breaker
BD-8123C	Suitable for mini and middle size moulded case circuit breakers with handle thickness $< 5\text{mm}$
BD-8123D	Suitable for mini and middle size moulded case circuit breakers with handle thickness $< 5\text{mm}$
BD-8123E	Suitable for large size moulded case circuit breakers
BD-8123F	Suitable for miniature circuit breakers with handle thickness $< 9.3\text{mm}$, middle size moulded case circuit breakers with handle thickness $< 12\text{mm}$



BD-8123A

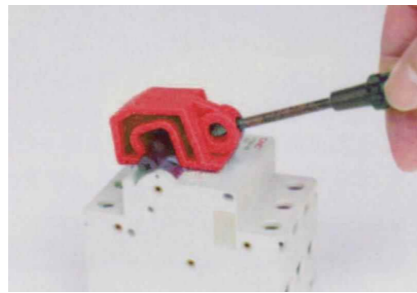

BD-8123B

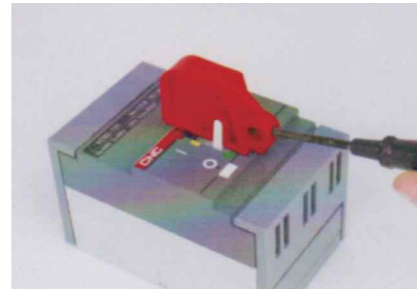

BD-8123C



BD-8123E

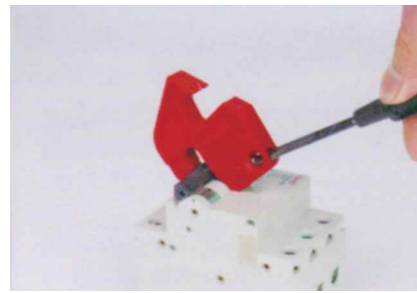

BD-8123F



BD-8123F

Knife-switch Lockout

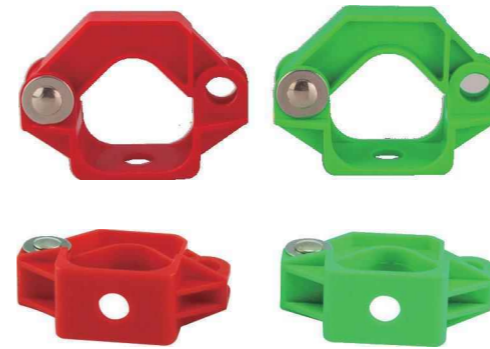

BD-8125

- Be made of ABS resin and has good insulation performance.
- One set includes a red and a green, and red indicates connection, green indicates disconnection.
- Use with professional safety padlock and tag together.



Description

Suitable for knife-switch

Moulded Case Circuit Breaker Lockout(small)



BD-8126

- Shell is made of ABS resin and main body is durable metal.
- External dimensions: Length 68.5mm, Width 23.5mm, Thickness 14mm.
- With a screw can tighten directly to install, easy to use, without assistant tools.
- Use with professional safety padlock and tag together.

Description

Suitable for the circuit breaker toggle switch thickness $\leq 10\text{mm}$, no limit for width.

suitable this kind of circuit breaker

Step1: Remove the adjustable block

Step2: Tighten the screw

Step3: Lockout and tagout

Moulded Case Circuit Breaker Lockout (big)



BD-81

- Shell is made of ABS resin and main body is durable metal.
- With a screw can tighten directly to install, easy to use, without assistant tools.
- Use with professional safety padlock and tag together.



Rotary screw



Adjusting block

Description

Suitable for the circuit breaker toggle switch width $\leq 60\text{mm}$, thickness $\leq 23\text{mm}$.



suitable this kind of circuit breaker



New Clamp-on Circuit Breaker Lockout

BD-8128A

- Made of sturdy polypropylene, high-strength modified nylon, and engineering plastic materials.
- Wide range of uses-suitable for various medium-sized molded case circuit breakers.
- Use the screw to fix the lockout on the switch handle, and then buckle the cover to the knob and finish locking to avoid loosening.
- Blade design makes the fit closer.
- A sliding long splint can ensure that the circuit breaker is locked.
- The detachable splint (included) further expands the scope of application.
- Padlocks with a maximum shackle diameter of 7mm can be used.
- Use with professional safety padlock and tag together.



Description

Lockable range: 10mm X 16mm

BD-8128B

- Made of sturdy polypropylene, high-strength modified nylon, and engineering plastic materials.
- Wide range of uses-suitable for various medium-sized molded case circuit breakers.
- Use the screw to fix the lockout on the switch handle, and then buckle the cover to the knob and finish locking to avoid loosening.
- Blade design makes the fit closer.
- A sliding long splint can ensure that the circuit breaker is locked.
- The detachable splint (included) further expands the scope of application.
- Padlocks with a maximum shackle diameter of 7mm can be used.
- Use with professional safety padlock and tag together.



Description

Lockable range: 13mm X 38mm



suitable this kind of circuit breaker

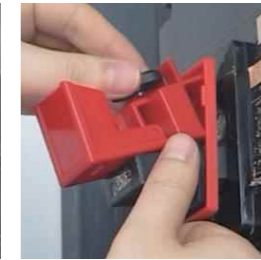

BD-8128C

- Made of sturdy polypropylene, high-strength modified nylon, and engineering plastic materials.
- Wide range of uses-suitable for various medium-sized molded case circuit breakers.
- Use the screw to fix the lockout on the switch handle, and then buckle the cover to the knob and finish locking to avoid loosening.
- Blade design makes the fit closer.
- A sliding long splint can ensure that the circuit breaker is locked.
- The detachable splint (included) further expands the scope of application.
- Padlocks with a maximum shackle diameter of 7mm can be used.
- Use with professional safety padlock and tag together.



Description

Lockable range: 22mm X 68mm



suitable this kind of circuit breaker



480V~600V Breaker Lockout

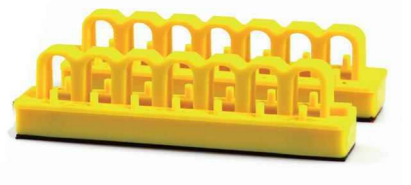
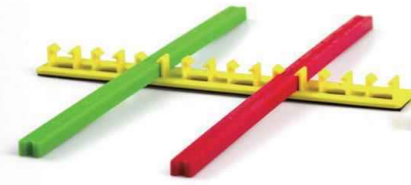

BD-8129

- Be made of ABS.
- Back self-adhesive track can fix on the distributor forever—clean the surface of the distributor no hole needed.
- To lock the special large or unique shape switch, the length of the rod is 19cm.
- Red stop rod means the switch is in the off state, green stop rod means the switch is in on state.
- Use with professional safety padlock and tag together.

Back self-adhesive track(can put stop rod isolated)

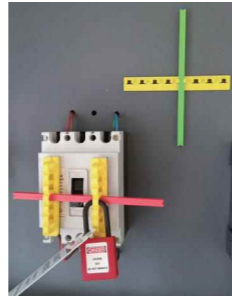

Description

Can accommodate two safety padlocks with shackle diameter ≤ 7mm.

Electrical Button Switch Lockout



BD-8141

- Be made of transparent ABS resin injection molding.
- Bottom border use double-sided adhesive tape to stick, easy to install.
- Use with professional safety padlock and tag together.

Description

Bottom hole diameter 29mm



Emergency Stop Lockout



BD-8131

- Be made of transparent acryl and eye-catching.
- Install on the push-pulled or knob released emergency stop button to prevent misoperation permanently.
- Use with professional safety padlock and tag together.



Description



BD-8132

- Be made of transparent acryl and eye-catching.
- Install on the push-pulled or knob released emergency stop button to prevent misoperation permanently.
- Use with professional safety padlock and tag together.



Description

Install hole diameter 30.5mm

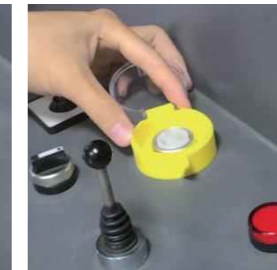

Universal Switch Lockout



BD-8142

- Be made of transparent ABS resin injection molding.
- Bottom border use double-sided adhesive tape to stick, easy to install.
- Use with professional safety padlock and tag together.

Description

Bottom square hole size 69mm X 69mm, applicable for most square switches

Quick Install Emergency Lockout



BD-8136

- Be made of transparent ABS resin injection molding.
- Bottom border use double-sided adhesive tape to stick, easy to install.
- Use with professional safety padlock and tag together.

Description

Diameter 62mm, height 54mm



| 22mm |



8133 Install Base

| 30.5mm |



8134 Install Base

| 34.5mm |



8135 Install Base



Quick Install Gear Switch Lockout

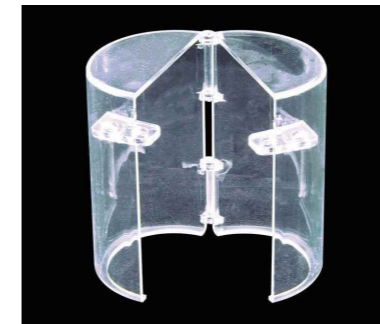

BD-8145

- Be made of transparent ABS injection molding, Base material: PC(polycarbonate).
- The lockout is made up of two parts: the lockout cover and the base. The base is fixed on the bottom of the switch.
- Just need to install or remove the lockout cover and easy to use.
- Use with professional safety padlock and tag together.

Description

Diameter 71.5mm, height 99mm



8143 Install Base



8144 Install Base



Electric Switch Lockout



BD-8151

- Be made of transparent ABS resin injection molding.
- External dimensions: Length 30mm, Width 28mm, Thickness 18mm.
- Bottom border use double-sided adhesive tape to stick, easy to install.
- Use with professional safety padlock and tag together.

Description

Bottom hole size: Length 28mm, Width 22.5mm

General Wall Switch Lockout

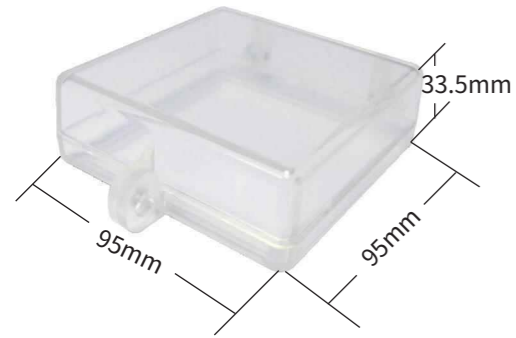

BD-8161

- Be made of industrial grade transparent ABS resin injection molding, beautiful and practical and can lock switch effectively. Prevent accidental operation.
- Applicable 110V ~ 220V Chinese standard 86 series wall switch.
- Lockout open method: up and down to open.
- Use with professional safety padlock and tag together.

Description

External dimensions: Length 95mm, Width 95mm, Thickness 33.5mm

BD-8171 (European and American Standards)

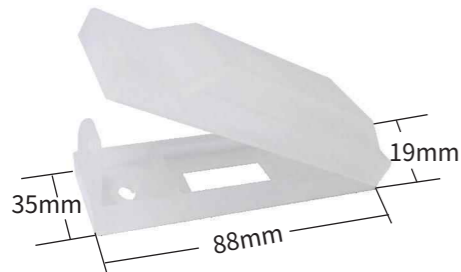

- Be made of industrial grade high strength polypropylene injection molding, beautiful and practical and can lock switch effectively. Prevent accidental operation.
- Applicable 110V ~ 220V European and American Standards wall switch.
- Lockout open method: up and down to open.
- Use with professional safety padlock and tag together.

Description

External dimensions: Length 88mm, Width 35mm, Thickness 19mm

BD-8162

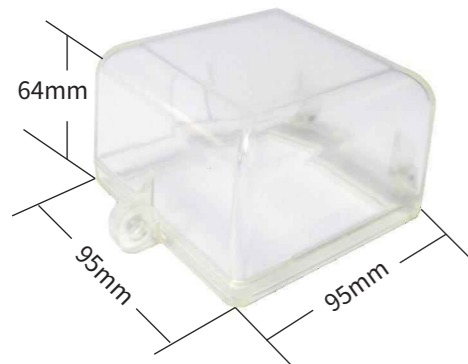

- Be made of industrial grade transparent ABS resin injection molding, beautiful and practical and can lock socket effectively. Prevent accidental operation.
- Applicable 110V ~ 220V Chinese standard 86 series wall socket
- Lockout open method: left and right to open.
- Use with professional safety padlock and tag together.

Description

External dimensions: Length 95mm, Width 95mm, Thickness 64mm

Plug Lockout



BD-8181

- Be made of ABS resin, side hole diameter 10mm.
- Stick with sunscreen label can write the name of the person in charge and matters.
- Use with professional safety padlock and tag together.

Description

External dimensions: Length 103mm, Width 60mm, Height 60mm



Big Plug Lockout



BD-8182

- Be made of ABS resin, side hole diameter 25mm.
- Four lock holes are available, multiple persons co-management to prevent accidental connection.
- Use with professional safety padlock and tag together.

Description

External dimensions: Length 178mm, Width 80mm, Thickness 85mm



Two-phase Plug



BD-8183

- Shell is made of ABS.
- Stick with sunscreen label can write the name of the person in charge and matters.
- Use with professional safety padlock and tag together.

Description

Applicable 220V two-phase flat plug



Three-phase Plug Lockout



BD-8184、8185

- Shell is made of ABS.
- Stick with sunscreen label can write the name of the person in charge and matters.
- Use with professional safety padlock and tag together.

Model	Description
BD-8184	Applicable 10A 220V three-phase power plug
BD-8185	Applicable 16A 220V three-phase power plug



European Standard Two-phase Plug Lockout



BD-8186

- Shell is made of ABS.
- Stick with sunscreen label can write the name of the person in charge and matters.
- Use with professional safety padlock and tag together.



Description
Applicable 220V two-phase round plug and European standard power plug

Trapezoidal Plug Lockout



BD-8187

- Shell is made of ABS.
- Use with professional safety padloc



Description
Provide lock protection for the computer host and electrical equipment

Crane Lift Controller Lockout Bag



- Made of sewing tear-resistant nylon fabric.
- There is a PVC barrier in the bag to prevent people from accidentally starting the controller button.
- The bag surface is marked with warning sign.
- Use with professional safety padlock and tag together.

Model	Description
BD-8191	Fasten with a strap, External dimensions: Length 450mm, Width 250mm
BD-8192	Fasten with a steel cable, External dimensions: Length 450mm, Width 250mm

5 Valve Lockout



Single Arm Universal Ball Valve Lockout



BD-8212

- Be made of reinforced nylon and metal, with better impact resistance and excellent chemical resistance.
- Advanced trapezoidal upper teeth improves the bite strength of valve handle.
- The rotating arm makes the bite more tight and improves the safety performance. Two gear adjustable.
- Use with professional safety padlock and tag together.

Description
External dimensions: Length 205mm, Width 50mm, Height 275mm Suitable for handle width ≤ 46 mm, suitable for handle maximum thickness ≤ 25 mm

Double Arms Universal Ball Valve Lockout



BD-8213

- Be made of reinforced nylon and metal, with better impact resistance and excellent chemical resistance.
- Advanced trapezoidal upper teeth improves the bite strength of valve handle.
- The rotating arm makes the bite more tight and improves the safety performance.
- Two gear adjustable.
- Use with professional safety padlock and tag together.

Description
External dimensions: Length 375mm, Width 50mm, Height 275mm Suitable for handle width ≤ 46 mm, suitable for handle maximum thickness ≤ 25 mm



Metal bite

Teeth mold bite

Two gear adjustable

Step 1

Step 2

Step 3

Ball Valve Lockout

BD-8211

- Be made of high strength polypropylene, excellent anti-fracture, wear resistance and insulation performance.
- Can adjust the position of the padlock arbitrarily, convenient and quick.
- Extended block design increase the suitable range.
- Applicable ball valve locking range: 0.25"-1" in open, 0.25"-1.5" in close.
- Use with professional safety padlock and tag together.

Description

External dimensions: Length 208mm, Width 77mm, Height 130mm

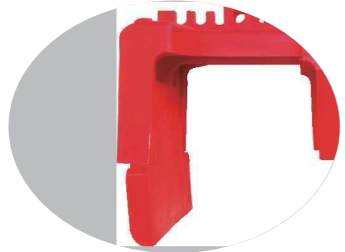
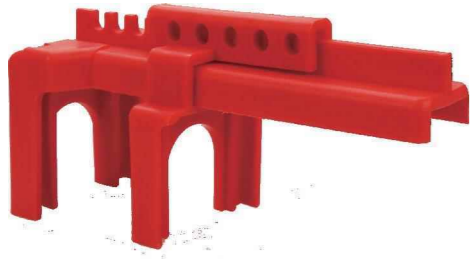

Rotation Valve Lockout

BD-8214

- Be made of reinforced nylon and stainless steel, durable and resistance to chemicals, corrosion resistance.
- Unique design to lock the flange ball valve from which handle can be removed or shut-off valve.
- Use with professional safety padlock and tag together.

Description

Suitable for handle $\leq 34\text{mm} \times 49\text{mm}$



PLUG VALVE LOCKOUT

BD-8218

- Material of Construction Polypropylene & stainless steel fastening belt
- suitable for valve diameter from 25.4mm (1 inch) to 203.2mm (8 inches)
- Designed to effectively secure a manual plug valve
- Durable and vandal resistant, Small size, easy to carry

How to Measure

Measure the dimension A to B (the diameter of the valve stem), and then select the appropriate plug lock according to the diameter of the valve stem

Easy to operate and easy to adjust

if the valve stem flat above the operating wrench and the clamp is fully occluded, the base and fixture of the plug valve lock can be left on the valve for backup, then remove the cover, the valve can be opened.

Description

Valve Diameter 44mm-52mm



BD-8218A BD-8218B



BD-8218C BD-8218D

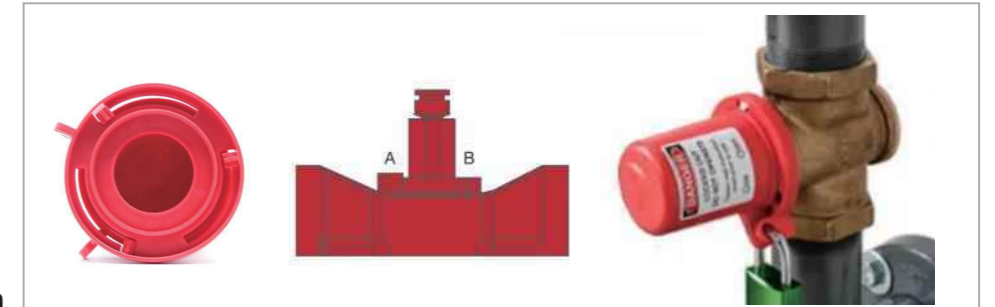

New Design Valve Lockout

BD-8215

- Be made of impact resistant ABS, corrosion resistance and better insulation performance.
- One-piece design, can lock the small right angle rotating ball valve in closed position.
- With a knob can tighten directly to install, easy to use, without assistant tools.
- Use with professional safety padlock and tag together.
- Suitable for locking 0.25"-1" ball valve handle in closed condition.

Description

A	B	C	D	E	F
90mm	78mm	20mm	77mm	48mm	7mm

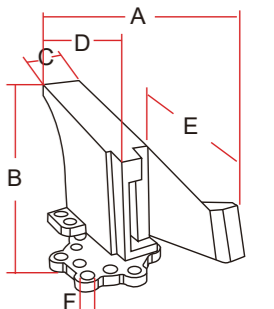

Step 1: Insert the ball valve handle

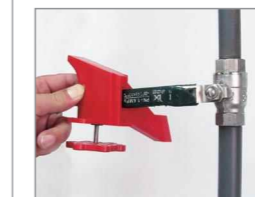

Step 2: Tighten the clamp to grip the ball valve handle



Step 3: Lock



New Design Metal Valve Lockout

BD-8216

- Heavy steel with painting.
- Easy to use, one-piece design, can lock the right angle turning ball valve in closed position.
- With a knob can tighten directly to install, easy to use, without assistant tools.
- Use with professional safety padlock and tag together.
- Suitable for locking 1.25"-2.5" ball valve handle in closed condition.

Description					
A	B	C	D	E	F
200mm	130mm	76mm	18mm	110mm	7.5mm

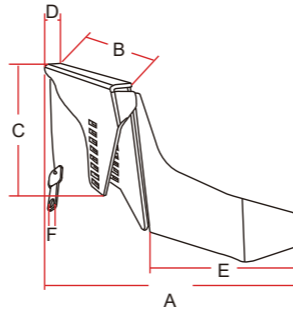

Butterfly Valve Lockout

BD-8221

- Be made of high strength polypropylene, excellent anti-fracture, wear resistance and insulation performance.
- Can adjust the position of the padlock arbitrarily, convenient and quick.
- Suitable for butterfly valve size: 0.25" - 2.5".
- Use with professional safety padlock and tag together.

Description
External dimensions: Length 300mm, Width 106mm, Height 67mm

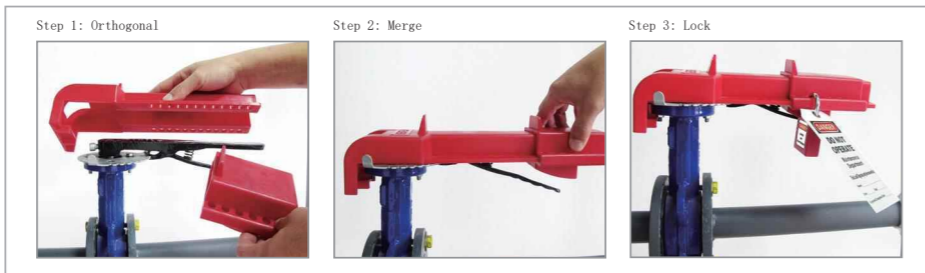

Butterfly Valve Lockout

BD-8222

- Be made of reinforced nylon PA6 and metal, with better impact resistance and excellent chemical resistance.
- Advanced trapezoidal upper teeth improves the bite strength of valve handle.
- Use with professional safety padlock and tag together.

Description
Suitable for handle width $\leq 46\text{mm}$, suitable for handle maximum thickness $\leq 25\text{mm}$



Butterfly Valve Lockout

BD-8223

- Be made of PP
- Suitable for part of butterfly valve lockout
- Other colors to be ordered. Chinese and English label can be choose.

Description
Valve rod diameter: width $\leq 42\text{mm}$, Max opening $\geq 14.5\text{mm}$, height: 5mm~35mm



Adjustable flange ball valve lockout



BD-8217

- Made of polypropylene.
- The maximum locking diameter is 9mm.
- Suitable to lock the DN8-DN125 flange ball valve which removed the valve handle.
- Colors can be customized.
- Warning labels in English and Chinese are optional.

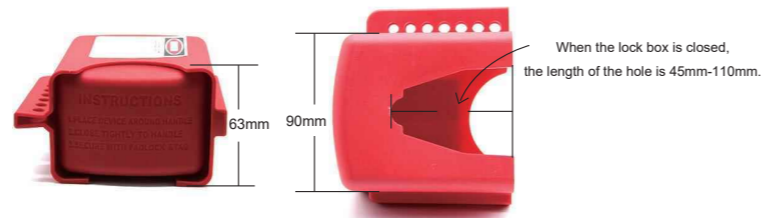

Description

Suitable to DN8-DN125 ball valve.



Flanged ball valve lockout bag

BD-8219

- The bag's main body is made of PC wear-resistant material, which is durable in harsh environment
- 3 safety padlocks ≤7mm can be locked at the same time
- The bag comes with a handle storage pocket to store accessories, easy to use and prevents accessories from being lost
- The fixing strap is made of PP, which makes the bag fixed stably

Description

Valve head diameter 30mm



Gate Valve Lockout

BD-8231~8235

- Be made of high strength engineering plastics, with better high temperature resistance, corrosion resistance, impact resistance and insulation performance.
- Unique design of central bulge, after removing, can be used for lifting rod gate valve.
- According to the handle diameter, there are 5 specifications lockout to choose.
- Stick with a warning label and indicate the application scope.
- Half moon flat box design, can completely lock the valve handle to prevent misoperation.
- Use with professional safety padlock and tag together.
- Two lockingholds for lockout&tagout.



Model	Description
BD-8231	Suitable for the handle diameter: 25mm-63mm, back hole diameter: 19mm, disassembled circular hole diameter: 19mm, thickness: 40mm
BD-8232	Suitable for the handle diameter: 63mm-127mm, back hole diameter: 32mm, disassembled circular hole diameter: 32mm, thickness: 40mm
BD-8233	Suitable for the handle diameter: 127mm-165mm, back hole diameter: 53mm, disassembled circular hole diameter: 53mm, thickness: 55mm
BD-8234	Suitable for the handle diameter: 165mm-254mm, back hole diameter: 70mm, disassembled circular hole diameter: 70mm, thickness: 75mm
BD-8235	Suitable for the handle diameter: 254mm-330mm, back hole diameter: 70mm, disassembled circular hole diameter: 70mm, thickness: 80mm

Gate Valve Lockout

- Made of imported DuPont alloy engineering plastics
- Different sizes, can be integrated into one when storing or carrying, reducing the volume by half
- 2-4 safety padlocks with shackle diameter ≤7mm can be locked
- Other colors to order. Chinese and English warning labels are available



BD-8235P

Material	ABS/PP
Description	Suitable for stem diameter (handwheel diameter) 330mm-450mm (13-18)
Hole diameter	123mm
Inner thickness	65mm



BD-8235B

Material	ABS/PP
Description	Suitable for stem diameter (handwheel diameter) 450mm-600mm (18-24)
Hole diameter	130mm
Inner thickness	65mm

Butterfly Valve Lockout

BD-8236

- Be made of reinforced nylon and metal, with better impact resistance and excellent chemical resistance.
- Suitable for handle width $\leq 46\text{mm}$, handle thickness $\leq 25\text{mm}$.
- Advanced trapezoidal upper teeth and opening design lower teeth are easy to hitch the valve handle and improve the bite strength of valve handle.
- Use with professional safety padlock and tag together.

Description

standard cable length 1.5m, diameter 3mm, the length can be customized as requests



Universal Valve Lockout

BD-8237

- Be made of reinforced nylon and metal, with better impact resistance and excellent chemical resistance.
- Suitable for handle width $\leq 46\text{mm}$, thickness $\leq 25\text{mm}$.
- BD-8237 has adjustable arm, can adjust the length of the arm according to customers' requests.
- Use with professional safety padlock and tag together.

Description

Can lock most of the ball valve, butterfly valve, gate valve; Standard cable length 1.5m, the length can be customized as requests

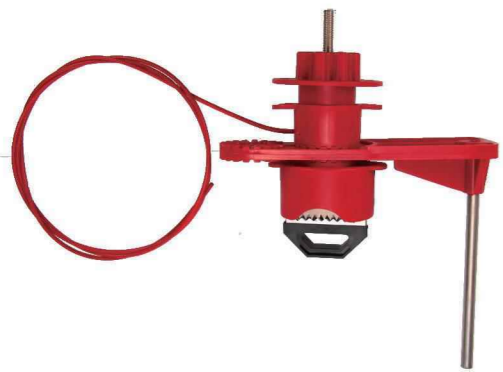

Universal Valve Lockout

BD-8238

- Be made of reinforced nylon and metal, with better impact resistance and excellent chemical resistance.
- Suitable for handle width $\leq 46\text{mm}$, thickness $\leq 25\text{mm}$.
- Use with professional safety padlock and tag together.

Description

Can lock most of the butterfly valve, gate valve; Standard cable length 2m, the length can be customized as requests



Adjustable Gate Valve Lockout

BD-8239

- Be made of ABS.
- A safety padlock with a lock shackle diameter
- Appearance: red, other colors need to be customized; warning labels in English.

Description

The locking range is adjustable, suitable for valve handle diameter: 25mm-165mm, thickness: 55mm



Pneumatic Lockout



BD-8241

- Be made of stainless steel, better antirust and corrosion resistance performance.
- Can lock air source made connector.
- Can lock air source made connector to prevent the air from being reconnected.
- External dimensions: Length 206mm, Width 33mm, Thickness 2.6mm.

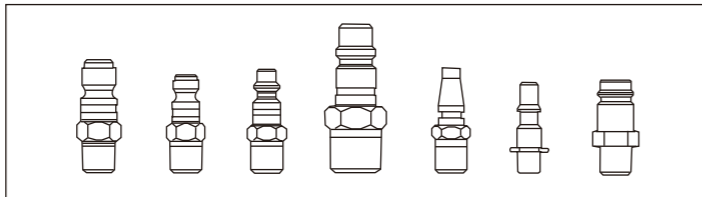

Pressurized Gas Cylinder Valve Lockout



BD-8251

- Be made of high strength industrial ABS resin, with better impact resistance, chemical pollution resistance.
- Lock the gas cylinder high pressure valve, prevent to open, suitable for valve with limiter.
- Applicable to all gas cylinder high pressure valves, valve diameter range can up to 76mm.
- External dimensions: 115mm X 97mm



6 Hasp Lockout



BD-8311

- Install the hasp lockout on the energy cut off switch so that the equipment cannot be operated during maintenance. It can be locked by multiple people at the same time.
- The equipment cannot be turned on unless the last person opens his/her padlock.



Description	Jaw Size
Steel jaw, polypropylene injection handle	1"

BD-8312

- Install the hasp lockout on the energy cut off switch so that the equipment cannot be operated during maintenance. It can be locked by multiple people at the same time.
- The equipment cannot be turned on unless the last person opens his/her padlock.



Description	Jaw Size
Steel jaw, polypropylene injection handle	1.5"

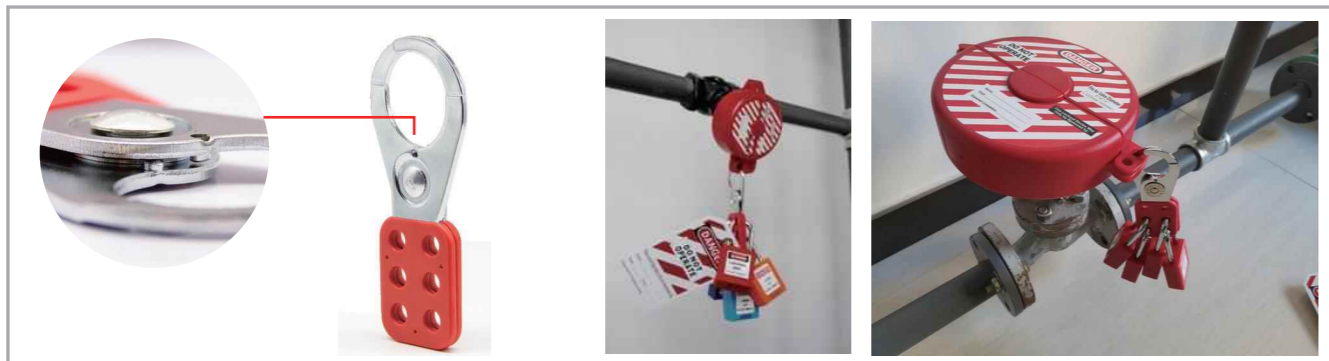

BD-8313

- Install the hasp lockout on the energy cut off switch so that the equipment cannot be operated during maintenance. It can be locked by multiple people at the same time.
- The equipment cannot be turned on unless the last person opens his/her padlock.



Description	Jaw Size
ABS resin lock body and nylon lock shackle, insulation, anti-chemical, anti-magnetic and non-conductive, Shackle size: 6.9mm X 4.2mm	78mm X 18mm

BD-8313A

- Install the hasp lockout on the energy cut off switch so that the equipment cannot be operated during maintenance. It can be locked by multiple people at the same time.
- The equipment cannot be turned on unless the last person opens his/her padlock.



Description	Jaw Size
ABS resin lock body and nylon lock shackle, insulation, anti-chemical, anti-magnetic and non-conductive, Shackle size: 5.8mm X 4mm	78mm X 18mm

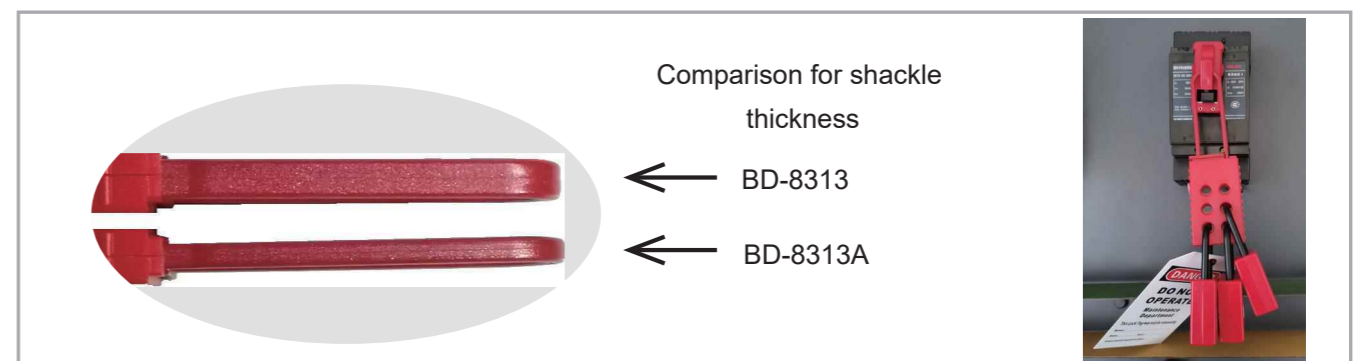

BD-8317

- Install the hasp lockout on the energy cut off switch so that the equipment cannot be operated during maintenance.
- The equipment cannot be turned on unless the last person opens his/her padlock.
- Can accommodate 6 people to lock, can be locked by multiple people at the same time.



1" Aluminum Hasp Lock with 6 Holes

Description	Jaw Size
Spark-proof aluminum jaw, polypropylene injection handle	1"

BD-8318

- Install the hasp lockout on the energy cut off switch so that the equipment cannot be operated during maintenance.
- The equipment cannot be turned on unless the last person opens his/her padlock.
- Can accommodate 6 people to lock, can be locked by multiple people at the same time.



1.5" Aluminum Hasp Lock with 6 Holes

Description	Jaw Size
Spark-proof aluminum jaw, polypropylene injection handle	1.5"



BD-8314

- Install the hasp lockout on the energy cut off switch so that the equipment cannot be operated during maintenance. It can be locked by multiple people at the same time.
- The equipment cannot be turned on unless the last person opens his/her padlock.



Description	Jaw Size
Zinc alloy, polypropylene injection handle	1.5"

New Design Hasp Lockout with 3 Holes



BD-8316

- Be made of heavy steel, shackle diameter is 6mm.
- Can accommodate 3 padlocks.
- Install the hasp lockout on the energy cut off switch so that the equipment cannot be operated during maintenance. can be locked by multiple people at the same time.
- The equipment cannot be turned on unless the last person opens his/her padlock.



Description
External dimensions: Length 111mm, Width 46mm, Thickness 10mm

Aluminum Hasp Lockout

BD-8321

- Be made of spark-proof aluminum, can accommodate 6 padlocks.
- External dimensions: Length 188mm, Width 76mm, Thickness 3.6mm.
- Install the hasp lockout on the energy cut off switch so that the equipment cannot be operated during maintenance.
- can be locked by multiple people at the same time.
- The equipment cannot be turned on unless the last person opens his/her padlock.
- Lock body has warning labels, can write user's information.



Aluminum Alloy Hasp Lockout

BD-8331

- Made of aluminum alloy.
- The traditional hasp and tag integration become one.
- The combination of label and hasp improve the applicability of the product, and the temperature-resistance design of tag can be applied to different environment.
- Both sides of the lable can be written.
- Color can be customized.



Aluminum Alloy Hasp Lockout

BD-8351

- Made from aluminum alloy.
- The traditional hasp and tag integration become one.
- The combination of label and hasp improve the applicability of the product, and the temperature-resistance design of tag can be applied to different environment.
- Both sides of the lable can be written.
- Color can be customized.



Description
Can accommodate 6 padlocks

Heavy Steel Hasp Lockout with 7 Holes

BD-8352

- Made of hardened steel, galvanized rustproof surface.
- Pry proof design.



Description
Can accommodate 7 padlocks

Insulation Hasp Lockout



BD-8341

- ABS lock body with nylon shackle.
- Apply to where place electric power isolation locking, high requirement of corrosive or explosion-proof places.
- Advantages: small and exquisite. Write available on the front and back.
- Can accommodate 4 padlocks.

Description
Lock shackle diameter 3mm



Stainless steel hasp lockout



BD-8353

- Made of SS304
- Not easy to be pried, strong, and durable
- The shackle diameter is 5mm

Model	Description
BD-8353	Can accommodate 6 padlocks



BD-8342

- ABS lock body with nylon shackle.
- Apply to where place electric power isolation locking, high requirement of corrosive or explosion-proof places.
- Advantages: small and exquisite, can be applied to 6mm lock hole.
- Write available on the front and back.
- Can accommodate 4 padlocks.

Description
Lock shackle diameter 6mm

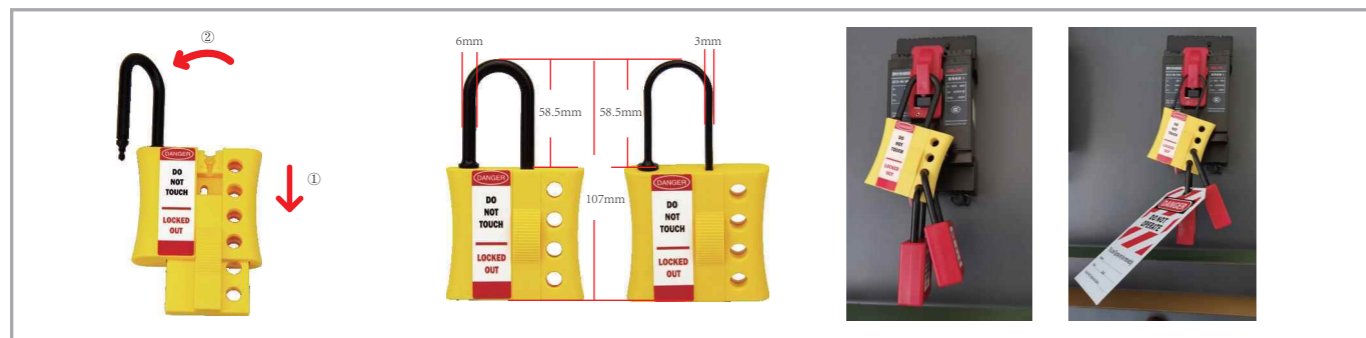
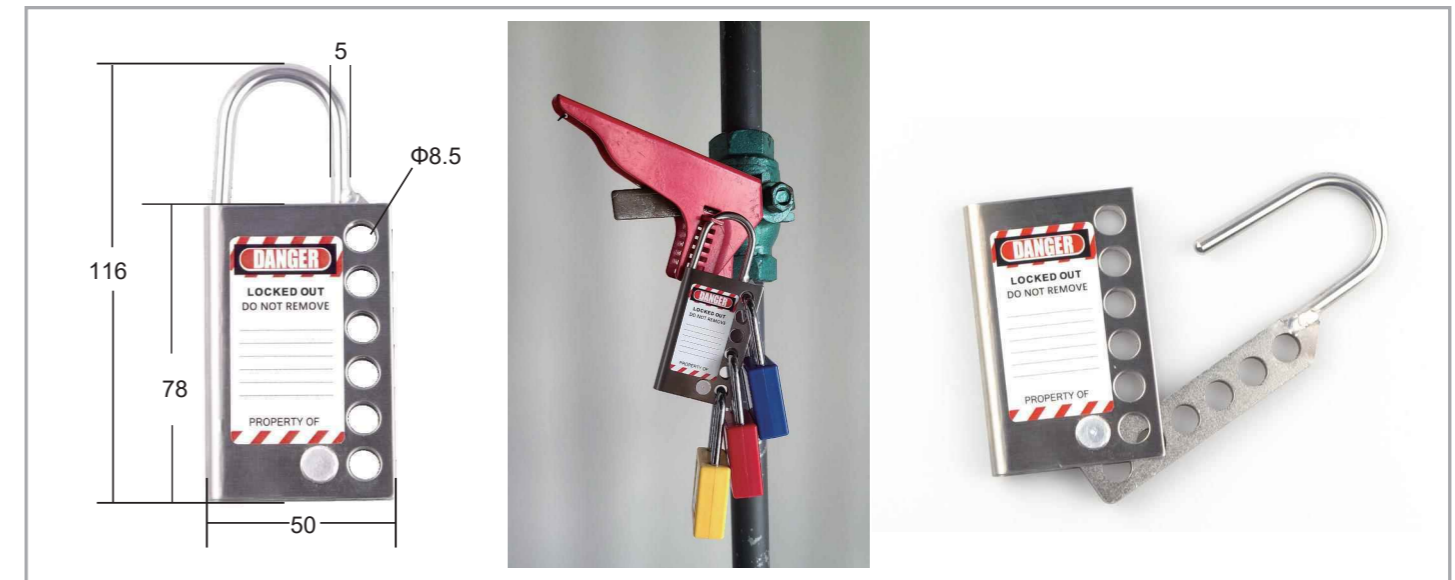

7 Cable Lockout



Cable Lockout



BD-8411

- Can lock valves of all sizes, electrical cabinet, and other locking points.
- easy to carry and widely used.
- Be made of ABS and stainless steel cable.
- Can accommodate 5 padlocks.
- Use with professional safety padlock and tag together.

Model	Description	External Dimensions
BD-8411	Stainless steel cable with PVC cover, 3mm diameter, 1.8m length. The length can be customized as requests	128mm X 85mm X 20mm



BD-8421

- Can lock valves of all sizes, electrical cabinet, and other locking points.
- easy to carry and widely used.
- Be made of ABS and stainless steel cable.
- Can accommodate 5 padlocks.
- Use with professional safety padlock and tag together.

Model	Description	External Dimensions
BD-8421	Stainless steel cable with insulation cover, 3mm diameter, 1.8m length. The length can be customized as requests	128mm X 85mm X 20mm

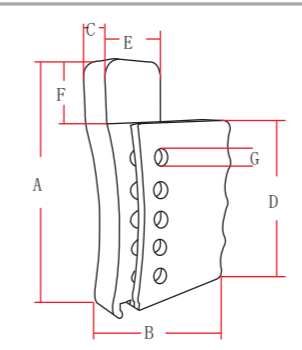

Model	size(mm)						
	A	B	C	D	E	F	G
BD-8411	128	85	20	100	32	28	9
BD-8421	128	85	20	100	32	28	9

Universal Cable Lockout

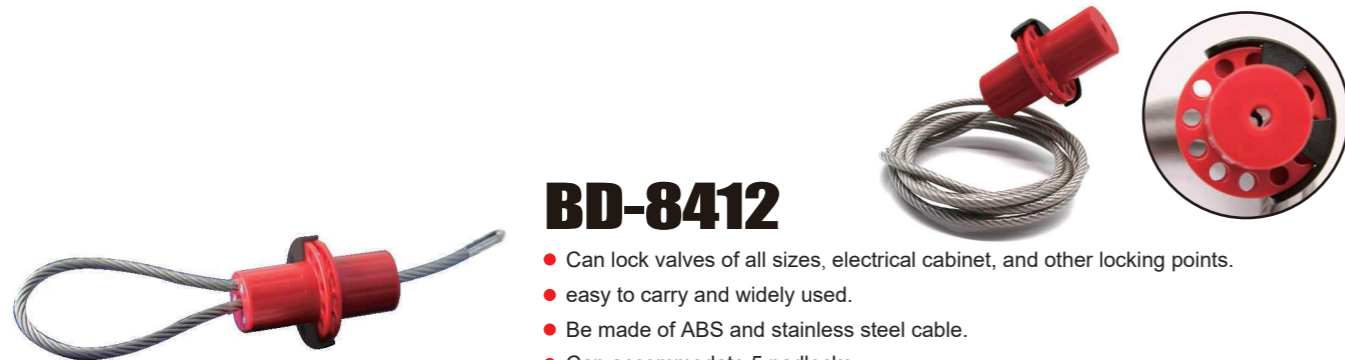

BD-8412

- Can lock valves of all sizes, electrical cabinet, and other locking points.
- easy to carry and widely used.
- Be made of ABS and stainless steel cable.
- Can accommodate 5 padlocks.
- Use with professional safety padlock and tag together.

Description

Stainless steel cable with PVC cover, 6mm diameter, 2m length. The length can be customized as requests



BD-8422

- Can lock valves of all sizes, electrical cabinet, and other locking points.
- easy to carry and widely used.
- Be made of ABS and stainless steel cable.
- Can accommodate 5 padlocks.
- Use with professional safety padlock and tag together.

Description

Stainless steel cable with insulation cover, 6mm diameter, 2m length. The length can be customized as requests

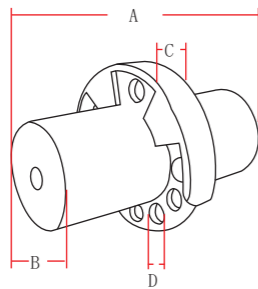

Model	size(mm)			
	A	B	C	D
BD-8412	85	34	13	7
BD-8422	85	34	13	7

Adjustable Cable Lockout



BD-8415

- Can lock valves of all sizes electrical cabinet, and other locking points. easy to carry and widely used.
- Be made of ABS and stainless steel cable.
- Can accommodate 4 padlocks.
- Use with professional safety padlock and tag together.

Description

Stainless steel cable with PVC cover, 4mm diameter, 1.8m length. The length can be customized as requests



BD-8416

- Can lock valves of all sizes electrical cabinet, and other locking points. easy to carry and widely used.
- Be made of ABS and stainless steel cable.
- Can accommodate 4 padlocks.
- Use with professional safety padlock and tag together.

Description

Stainless steel cable with PVC cover, 6mm diameter, 1.8m length. The length can be customized as requests



Universal Fish-shaped Insulation Cable Lockout



BD-8431

- Can lock valves of all sizes, electrical cabinet, and other locking points. easy to carry and widely used.
- Be made of ABS and stainless steel cable, with insulation cover.
- Can accommodate 6 padlocks.
- Use with professional safety padlock and tag together.
- Cable diameter 5mm, 2m length, the length can be customized as requests.

Description

Length 150mm, Width 57mm, Thickness 12mm

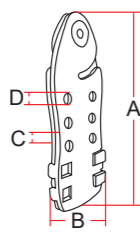

Model	size(mm)			
BD-8431	A	B	C	D
	150	57	12	8.5

Pipeline High-pressure Ball Valve Lockout



BD-8432

- Red tear-resistant nylon fabric, strong warning, PVC barrier in the bag.
- Suitable for locking of high pressure ball valves on densely arranged and small spacing pipeline groups (such as oil pipelines in hydraulic stations, gas pipelines in gas stations).
- According to actual pipeline spacing or demand, can lock one or more high-pressure ball valves.

Description

External dimensions: 457mm X 500mm Cable length: 2m, Diameter 5mm



Double Holes Cable Lockout



BD-8451

- Can lock all kinds of devices flexibly.
- More convenient than ordinary chain and easy to use.
- Red insulation stainless steel cable, colorful and durable.
- The length can be made as per requests.
- Use with professional safety padlock and tag together.

Description

Cable diameter 5mm, length 2m

Grip-cinching Cable Lockout



BD-8413

- Made from impact resistant nylon.
- 1.6 meter stainless steel cable, the outer layer of cable is made from anti-UV PVC (diameter 4mm).
- Self-locking function, the cable lock is self-locking under the condition of not being operated, ensuring that the cable is not arbitrarily stretched, and the locking function is strong.
- Can write the label (in Chinese or in English) to identify the operator.
- Locked with 5 padlocks, which shackle diameter is less than 7mm.



Description

Include cable, the lock is open when the handle is in the bounce position

Adjustable Cable Lockout



BD-8414

- Lock body is made of anti-impact nylon (PA);
- The cable is made of stainless steel with anti-UV PVC cover;
- Cable length: 2.4m or customized length;
- Diameter: 3.5mm;
- Color: red or customized other colors;
- Padlock hole quantity: 1, can accommodate 1 padlock with diameter less than 7mm;
- Customization: cable length and color can both be customized.



Description

Cable length: 2.4m, diameter: 3.5mm

Miniature Cable Lockout



BD-8449

- Made from impact resistant nylon.
- 300mm stainless steel cable, the outer layer of cable is made from anti-UV PVC (diameter 1.5mm).
- Red part: push up to release the cable, push down to lock the cable.
- There is a "lockout" reminder faction on the bottom of red part.
- After locking, the cable can only be tightened.
- Can customize label (in Chinese or in English).
- Φ6mm and Φ8mm hole, suitable for different types of shackles.



Description

Include cable

Cable padlock



BD-8441

- ABS lock body and 3mm diameter stainless steel cable.
- Can lock neighboring electrical appliances or other switch at the same time, saving the padlocks quantity and space, easy to manage.
- Use with professional safety padlock and tag together.



Model	Description
BD-8441	Keyed to differ cable padlock, The cable length is 150mm
BD-8443	Keyed alike cable padlock, The cable length is 150mm
BD-8445	Master&alike cable padlock, The cable length is 150mm
BD-8447	Master&differ cable padlock, The cable length is 150mm



BD-8442

- ABS lock body and 3mm diameter stainless steel cable.
- Can lock neighboring electrical appliances or other switch at the same time, saving the padlocks quantity and space, easy to manage.
- Use with professional safety padlock and tag together.



Model	Description
BD-8442	Keyed to differ cable padlock, The cable length is 240mm
BD-8444	Keyed alike cable padlock, The cable length is 240mm
BD-8446	Master&alike cable padlock, The cable length is 240mm
BD-8448	Master&differ cable padlock, The cable length is 240mm

Retractable Cable Lockout



BD-8461

- ABS lock body and stainless steel cable.
- Unique and scientific retractable design, easy to use and stock.
- 3mm diameter, 2m length cable with insulation cover. Structure design confirms to lock firmly.
- Use with professional safety padlock and tag together.

Description

External dimensions: Length 134mm, Width 105mm, Thickness 37mm

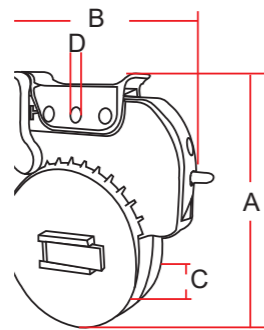

Model	size(mm)			
	A	B	C	D
BD-8461	134	105	37	7

Automatic Retractable Cable Lockout

BD-8462

- The lock body is made by high-strength polycarbonate PC material
- 1.8m stainless steel cable, the outer layer of the cable is made of UV-resistant PVC (diameter 2.0mm)
- This product has an automatic retraction function. After pressing the button, the excess cable will automatically retract and tightened. It is easy to operate, portable and durable
- 2 safety padlocks with shackle diameter ≤ 7 mm can be locked



Description

Include cable



Press the button to pop up to open, the cable can be extended as needed



Press the side button lightly and the cable retracts automatically, leaving the length as needed



Take your finger off the side button, the cable will stop, and finally press the "up button" to use the padlock

Manhole Lockout



BD-8471

- The product is made of high-quality wear-resistant polyester cloth and uses high-quality technology to make the product more durable in harsh environments.
- Only need to penetrate the three straps into the side holes ≥ 16 mm, then straighten the straps, and lock the corresponding hole position of each strap with padlocks to realize the lock.
- With professional design, different sizes of pipes can be locked (without changing their size).

Description

Belt with holes, use with professional safety padlock and tag together.
External dimensions: Side length 490mm The strap length is 830mm



BD-8472

- The product is made of high-quality wear-resistant polyester cloth and uses high-quality technology to make the product more durable in harsh environments.
- Only need to penetrate the three straps into the side holes ≥ 16 mm, then straighten the straps, and lock the corresponding hole position of each strap with padlocks to realize the lock.
- With professional design, different sizes of pipes can be locked (without changing their size).

Description

Cable, use with professional safety padlock and tag together.
Cable length: 2m, Diameter 5mm



8 Lockout station



4 Padlock Lockout Station

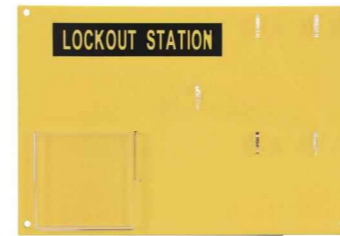

BD-8713

- Be made of ABS resin, corrosion resistant, impact resistant, easy for daily management.
- External dimensions: Length 301mm, Width 221mm.
- Four corners with holes, easy to install.



Parts for Reference

Model	Description		
Parts for reference	BD-8521 red 4pcs	BD-8311 3pcs	BD-8611 25pcs

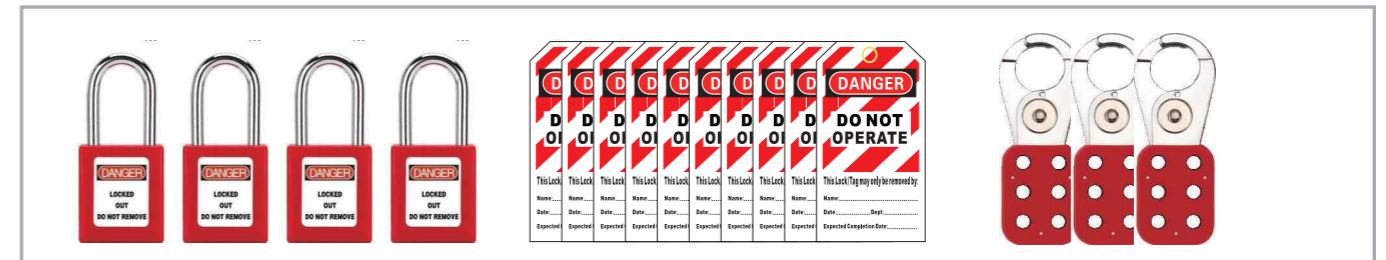

4 Padlock Lockout Station with Cover



BD-8714

- Be made of ABS resin, corrosion resistant, impact resistant.
- With transparent polycarbonate cover, can be locked, easy for daily management.
- External dimensions: Length 307mm, Width 228mm, Thickness 65mm.
- Four corners with holes, easy to install.



Parts for Reference

Model	Description		
Parts for reference	BD-8521 red 4pcs	BD-8311 3pcs	BD-8611 25pcs

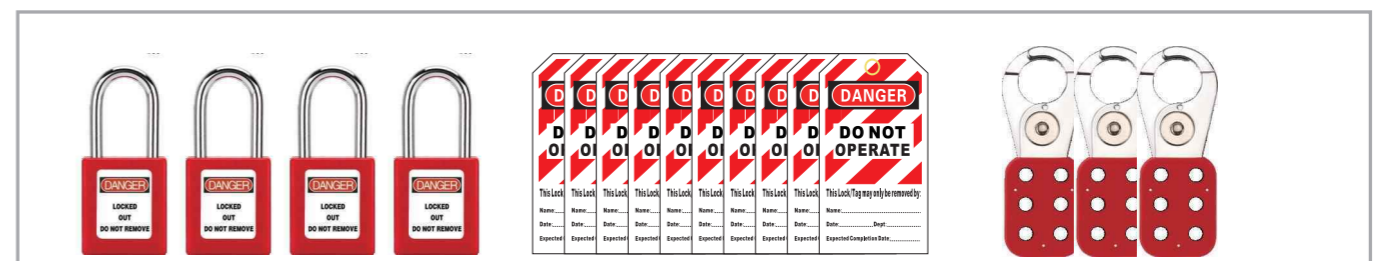

10 Padlock Lockout Station



BD-8723

- Be made of ABS resin, corrosion resistant, impact resistant, easy for daily management.
- External dimensions: Length 480mm, Width 300mm.
- Four corners with holes, easy to install.

Model	Description		
Parts for reference	BD-8521 red 10pcs	BD-8311 3pcs	BD-8611 25pcs

Parts for Reference

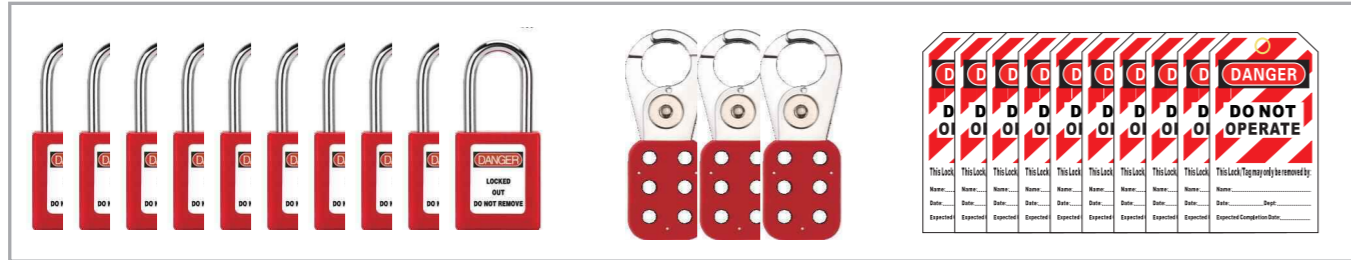

10 Padlock Lockout Station with Cover



BD-8724

- Be made of ABS resin, corrosion resistant, impact resistant, easy for daily management.
- External dimensions: Length 487mm, Width 308mm, Thickness 65mm.
- Four corners with holes, easy to install.

Model	Description		
Parts for reference	BD-8521 red 10pcs	BD-8311 3pcs	BD-8611 25pcs

Parts for Reference



20 Padlock Lockout Station

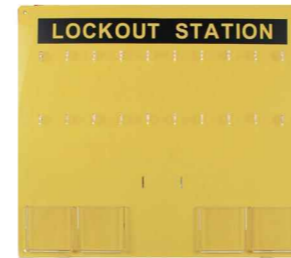

BD-8733

- Be made of ABS resin, corrosion resistant, impact resistant, easy for daily management.
- External dimensions: Length 550mm, Width 480mm.
- Four corners with holes, easy to install.

Model	Description			
Parts for reference	BD-8521 red 20pcs	BD-8312 3pcs	BD-8311 3pcs	BD-8611 50pcs

Parts for Reference

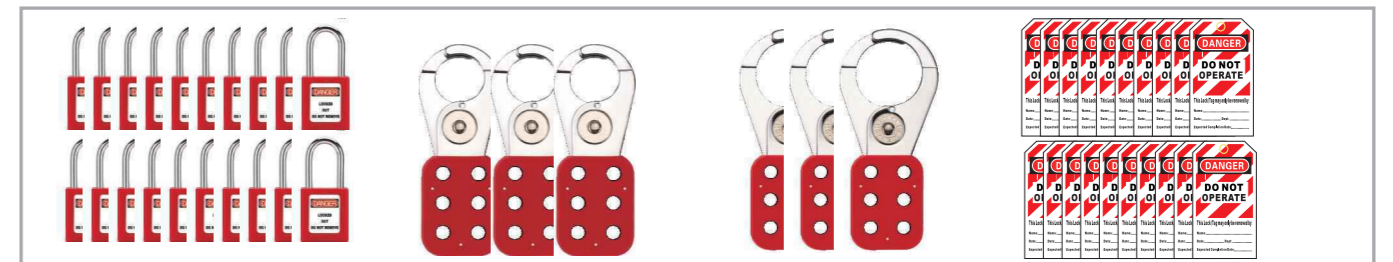

98

20 Padlock Lockout Station with Cover



BD-8734

- Be made of ABS resin, corrosion resistant, impact resistant.
- With transparent polycarbonate cover, can lock, easy for daily management.
- External dimensions: Length 558mm, Width 490mm, Thickness 65mm.
- Four corners with holes, easy to install.

Model	Description			
Parts for reference	BD-8521 red 20pcs	BD-8312 3pcs	BD-8311 3pcs	BD-8611 50pcs

Parts for Reference

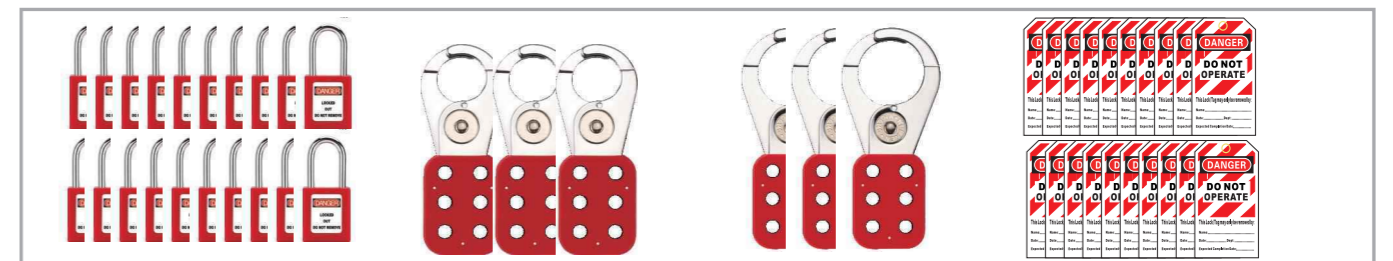

36 Padlock Lockout Station

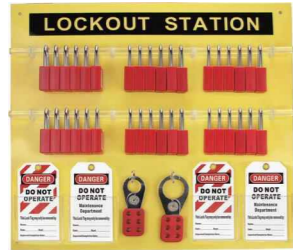

Parts for Reference

BD-8742

- Be made of ABS resin, corrosion resistant, impact resistant.
- External dimensions: Length 550mm, Width 480mm.
- Four corners with holes, easy to install.

Model	Description			
Parts for reference	BD-8521 red 36pcs	BD-8312 3pcs	BD-8311 3pcs	BD-8611 50pcs

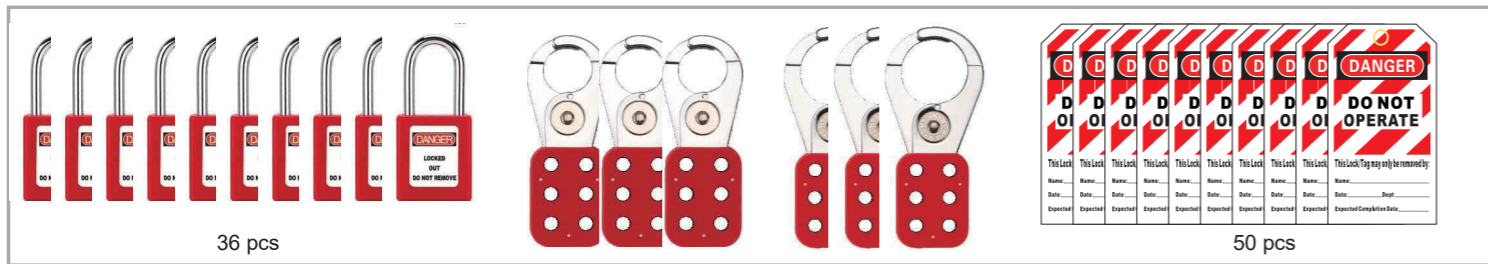

Combination Padlock Station

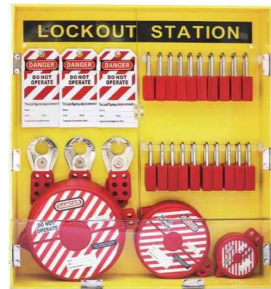

Parts for Reference

BD-8752

- Be made of ABS resin, corrosion resistant, impact resistant.
- With transparent polycarbonate cover, can lock, easy for daily management.
- External dimensions: Length 500mm, Width 467mm, Thickness 104mm.
- Four corners with holes, easy to install.

Model	Description			
Parts for reference	BD-8521 red 20pcs	BD-8312 3pcs	BD-8311 3pcs	BD-8611 25pcs
	BD-8233 1pcs	BD-8232 1pcs	BD-8231 1pcs	



Metal Lockout Station



BD-8737

- Be made of steel sheet with high temperature sprayed.
- Warning yellow, beautiful and eye-catching.
- There are two pieces removable partition, can set interlayer space according to the requests flexibly.
- Can be hung on the wall or carried with you.
- There is a padlock hole on the station cover, easy to manage and lock.

Description
External dimensions: Length 360mm, Width 450mm, Height 155mm



BD-8738



- Be made of the steel with high temperature spraying.
- Warning yellow, beautiful and eye-catching.
- There are 30 hooks for locking, each hook can hang two padlocks or hasp lockout.
- Can be hung on the wall or carried with you.
- There has padlock hole on the station cover, easy to manage and lock.

Description
External dimensions: Length 560mm, Width 460mm, Height 70mm

BD-8739



- Be made of steel sheet with resin sprayed.
- Warning red, beautiful and eye-catching.
- There has 22 hooks for padlock, each hook can hang two padlocks and hasp lockout, can put 4 warning signs.
- Can be hung on the wall or carried with you.
- There has padlock hole on the station cover, easy to manage and lock.

Description
External dimensions: Length 560mm, Width 430mm, Height 90mm

Combined Lock Management Station

It is made of ABS engineering plastic and PC material, one-piece design which is solid and durable

It can be used to hang safety padlock or hasp

It can be used to place marker pens and others

Design with mask

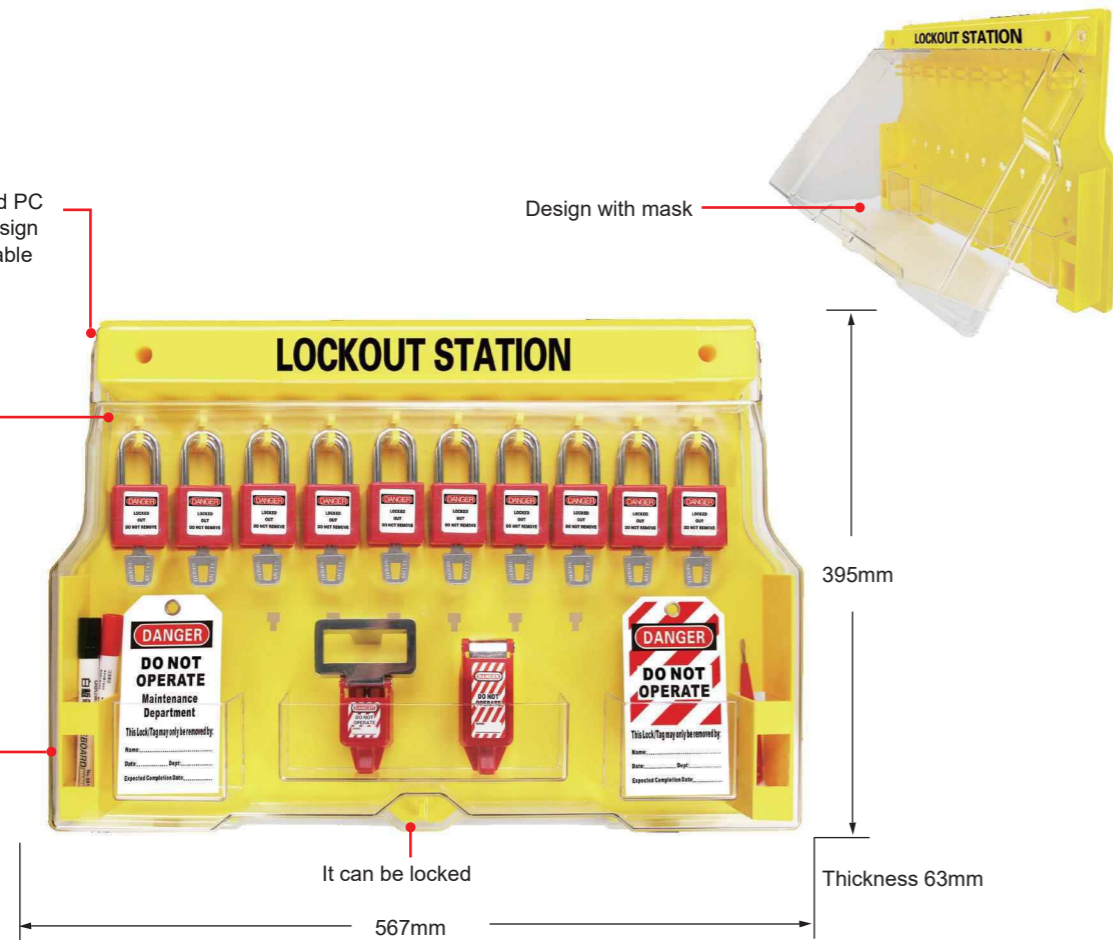

BD-8757A (Locks are not included when shipped)

Model	Description
BD-8757A	Equipped with 10 padlock hooks and 3 material boxes, it can hold up to 20 padlocks, some tags and small locks
BD-8757B	Equipped with 16 padlock hooks and 2 material boxes, it can hold up to 32 padlocks, some tags and small locks
BD-8757C	Equipped with 14 padlock hooks and 1 material box, it can hold up to 28 padlocks, some tags and small locks
BD-8757D	Equipped with 20 hook locks, up to 40 padlocks

Demo effect



BD-8757B

(Locks are not included when shipped)

Demo effect



BD-8757C

(Locks are not included when shipped)

Demo effect

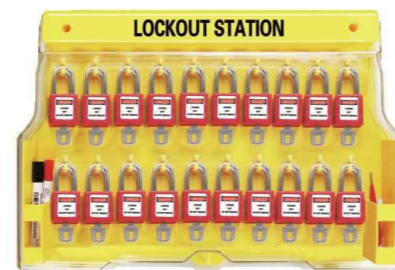

BD-8757D

(Locks are not included when shipped)

Lockout Kit

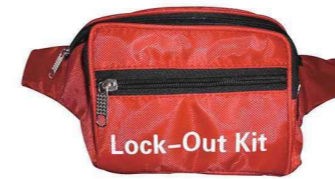

BD-8771

- Warning red, safe and eye-catching.
- External dimensions: Length 210mm, Width 145mm, Thickness 60mm.
- Small zipper bag, easy to carry, or wear the adjustable belt on waist.

Model	Description			
Parts for reference	BD-8521 red 1pcs	BD-8611 1pc	BD-8111 1pc	BD-8121A 1pc
	BD-8511 red 1pc	BD-8231 1pc	BD-8311 1pc	BD-8312 1pc

Parts for reference



BD-8772

- The color is yellow and black. Printing Lock-Out Kit. There are multiple small pockets inside and outside the bag for easy storage of small locks, double-layer thick Oxford cloth.
- External dimensions: Length 300mm, Width 220mm, Thickness 240mm.
- Large capacity, can pack many safety lockout, portable and easy to carry.
- Include many lockout parts, meet most of the application. Can be used for many people.

Model	Description			
Parts for reference	BD-8611 10pcs	BD-8111 2pcs	BD-8121A 2pcs	BD-8211 1pc
	BD-8421 1pc	BD-8231 1pc	BD-8232 1pc	BD-8233 1pc
	BD-8312 1pc	BD-8313 1pc	BD-8521 red 3pcs	BD-8511 red 2pcs
	BD-8311 2pcs	BD-8411 1pc		



Parts for reference



Combination Lockout Box



BD-8773A

- Full plastic design, simplicity but not simple.
- Rubber handle with one-piece part box.
- BD - 8773A dimensions: Length 360 mm, Width 180 mm, Height 180 mm, net weight is 1.0 KG.

Parts for reference

BD-8611 10pcs	BD-8111 2pcs	BD-8121A 2pcs	BD-8431 1pc	BD-8231 1pc
BD-8311 2pcs	BD-8312 1pc	BD-8313 1pc	BD-8521 red 2pcs	BD-8511 red 1pc



BD-8773B

- Full plastic design, simplicity but not simple.
- Rubber handle with one-piece part box.
- BD - 8773B dimensions: Length 360 mm, Width 180 mm, Height 180 mm, net weight is 1.25 KG.

Parts for reference

BD-8611 10pcs	BD-8111 2pcs	BD-8121A 2pcs	BD-8431 1pc	BD-8231 1pc
BD-8311 2pcs	BD-8312 1pc	BD-8313 1pc	BD-8521 red 2pcs	BD-8511 red 1pc



Combination Lockout Box



BD-8774A

- Thicken new box, be made of high quality PP plastic.
- Removable independent part box.
- BD - 8774A dimensions: Length 470 mm, Width 240 mm, Height 200 mm, net weight is 1.6 KG.

Parts for reference

BD-8611 10pcs	BD-8111 2pcs	BD-8121A 2pcs	BD-8431 1pc	BD-8231 1pc
BD-8311 2pcs	BD-8312 1pc	BD-8313 1pc	BD-8521 red 3 pcs	BD-8511 red 2pc
BD-8421 1pc	BD-8231 1pc	BD-8232 1pc	BD-8233 1pc	BD-8311 2pcs



BD-8774B

- Thicken new box, be made of high quality PP plastic.
- Removable independent part box.
- BD - 8774B dimensions: Length 470 mm, Width 240 mm, Height 200 mm, net weight is 2.0 KG.

Parts for reference

BD-8611 10pcs	BD-8111 2pcs	BD-8121A 2pcs	BD-8431 1pc	BD-8231 1pc
BD-8311 2pcs	BD-8312 1pc	BD-8313 1pc	BD-8521 red 3 pcs	BD-8511 red 2pc
BD-8421 1pc	BD-8231 1pc	BD-8232 1pc	BD-8233 1pc	BD-8311 2pcs



Combination Draw-bar Lockout Box

BD-8775



- Combination draw-bar lockout box, load-bearing ability, convenient and more practical, multi-story design, reasonable structure, suitable for different industries.
- High quality and light wheels, flexible mobile, three layers combination, solid metal connection, multi-functional.
- External dimensions: Length 520mm, Width 320mm, Height 720mm.
- The first layer internal dimensions: Length 440mm, Width 220mm, Height 200mm.
- The second layer internal dimensions: Length 390mm, Width 210mm, Height 60mm.
- The third layer internal dimensions: Length 410mm, Width 200mm, Height 280mm.
- Be made of carbon steel and ABS, net weight is 15.8 KG.



Portable Lockout Box

- Be made of carbon steel, red , can customize yellow or brown according to the requests.
- External dimensions: Length 260mm, Width 103mm, Height 152mm.
- Each locking point on equipment needs one padlock to secure the safety. Collect these keys and put into the box and each authorized worker locks his padlock on the box.
- After work, workers remove their own padlock from the box, then the keys can be got in the box.
- For BD-8812/8813, Only the last worker removes his/her padlock, can get the keys in the box.



BD-8811

BD-8812

BD-8813

Model	Description
BD-8811	Only one lock hole, suitable for single management
BD-8812	13 lock holes easy for multi-person co-management. Only the last worker removes his/her padlock, can get the keys in the box
BD-8813	13 lock holes, One side is transparent and visual management, which is convenient for many people to manage together

Portable Safety Padlock Rack



BD-8765

- This product is made of reinforced nylon injection molding.
- Warning label in English.
- Can accommodate 12 padlocks.
- Lock holes diameter: 9mm.

Description
External dimensions: Length 131mm, Width 187mm

Safety Padlock Rack



62

BD-8763

BD-8764

BD-8761~8764

- Be made of carbon steel with red spraying, safe and eye-catching.
- Used for hanging safety padlocks (padlocks need to be additionally configured).
- Four specifications to choose.

Model	Description
BD-8761	Length 140mm, Width 40mm, Height 80mm, can hang 5pcs padlocks
BD-8762	Length 270mm, Width 40mm, Height 80mm, can hang 10pcs padlocks
BD-8763	Length 400mm, Width 40mm, Height 80mm, can hang 15pcs padlocks
BD-8764	Length 530mm, Width 40mm, Height 80mm, can hang 20pcs padlocks

Multifunctional Pull Rod Management Box



BD-8776

- The pull rod lock box has strong bearing capacity, convenient and practical, reasonable structure, and is suitable for different industries.
- Big wheel design, strong and durable, flexible movement.
- 10 mm diameter solid metal rod is strong and durable, which is more suitable for people under 1.80m in height.
- The lock box is of inverted trapezoidal structure, with internal dimension of 42.5cm in length and 22.5cm in width at the bottom, 50cm in length and 24.5cm in width at the top, and 33cm in clear height.
- External dimension: length 54mm * width 30mm, height 39mm, this external dimension is the maximum distance measurement.
- Material: engineering plastics (ABS) + carbon steel rod, net weight 4.8kg.

Key Management Cabinet

BD-800

- Be made of the steel with high temperature spraying.
- Can be hung on the wall or easy to carry.
- There is a navel lock on the lock box door for easy management and locking.



BD-800(48)



Parts for reference



BD-800(100)

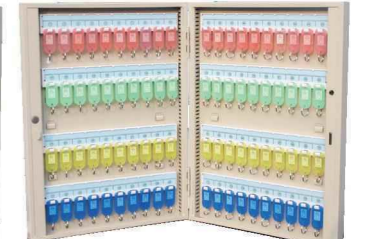

Parts for reference

Model	Product Name	External Dimensions
BD-800(30)	30 key box	380mm X 210mm X 50mm
BD-800(48)	48 key box	380mm X 300mm X 50mm
BD-800(64)	64 key box	480mm X 305mm X 50mm
BD-800(80)	80 key box	495mm X 370mm X 60mm
BD-800(100)	100 key box	610mm X 360mm X 60mm
BD-800(120)	120 key box	740mm X 360mm X 60mm
BD-800(160)	160 key box	610mm X 380mm X 90mm
BD-800(200)	200 key box	730mm X 370mm X 110mm
BD-800(240)	240 key box	620mm X 385mm X 140mm

9

Floor Marking Tape Dispenser



Floor Marking Tape Dispenser

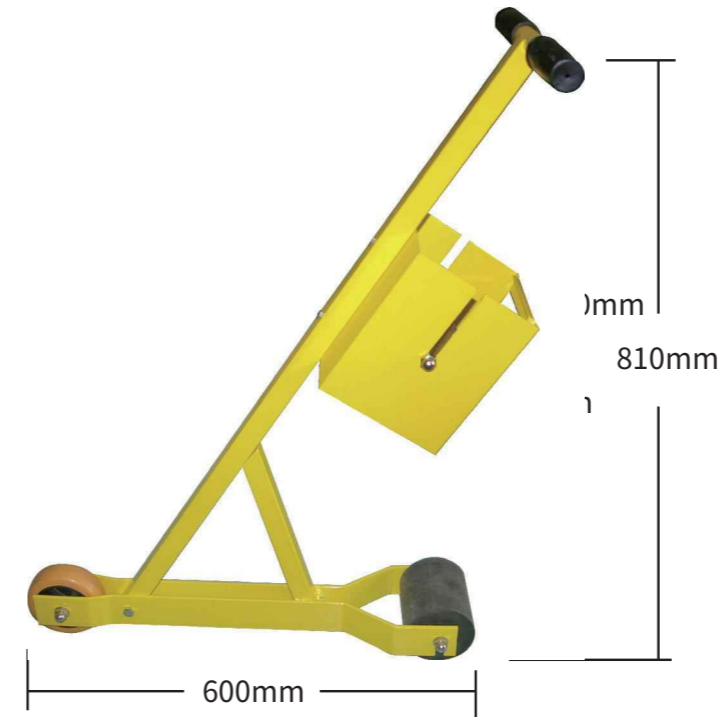

BD-8911

- Use tape dispenser to mark line on the ground can improve the work efficiency, reduce workers intensity, ensure quality of the line, save time and labor.
- Metal frame structure, light and durable.
- The maximum tape width is 100 mm.

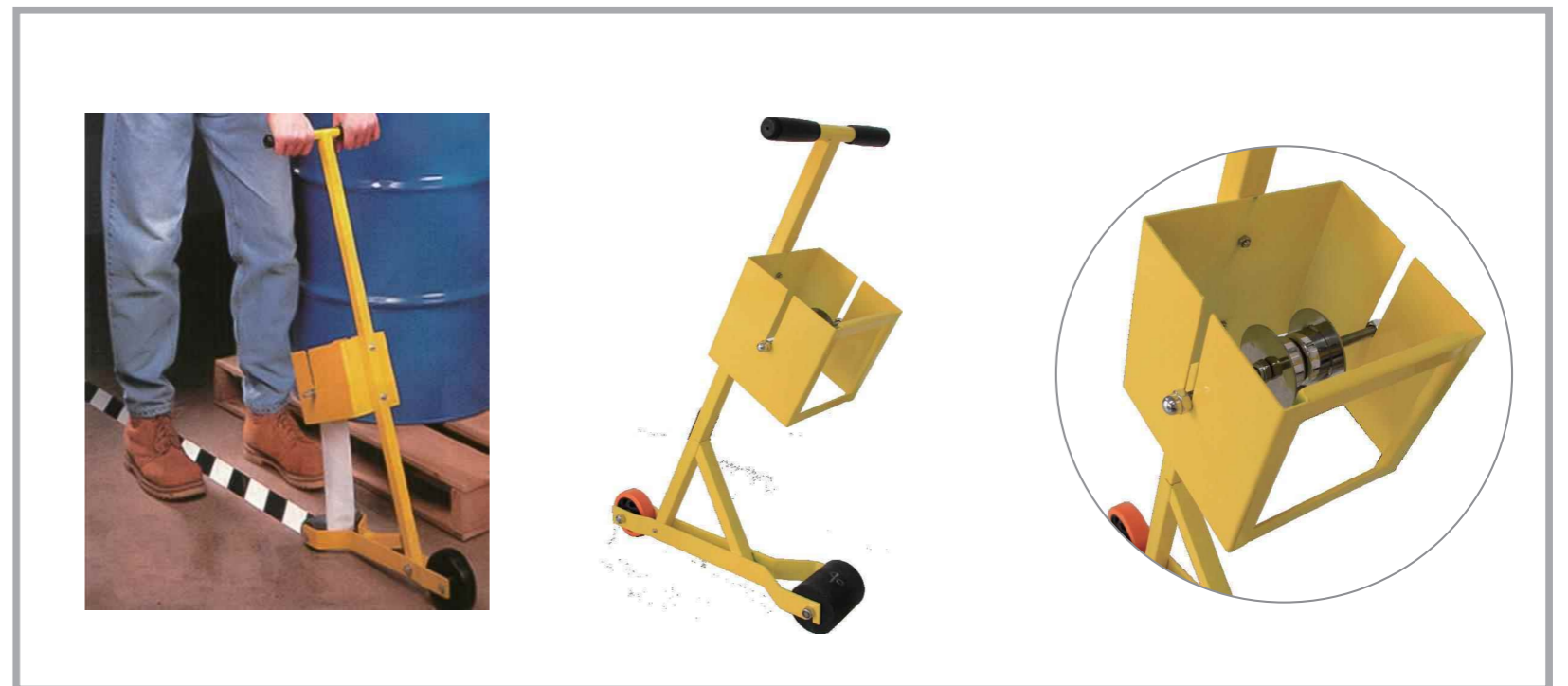

10 Disposable Steel Wire Lock

Disposable Steel Wire Lock

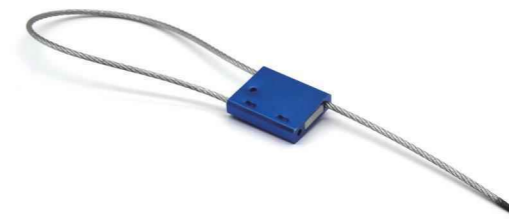

BD-8001~8003

- Easy to lock, insert the tip of the steel wire into the hole and lock it
- This product is a one-time product and cannot be opened after being locked unless it is maliciously damaged
- Special pressing, the special gear does not loosen, does not slip, and is not easy to break
- Anti-oxidation, Anti-exposure, Anti-corrosion
- Can print logo, code, word.

Model	Description
BD-8001	Single-use Cable Seal Lock (Flat Lock Body) Lock body dimensions: 22*26*6mm Cable diameter: 1.5mm
BD-8002	Single-use Cable Seal Lock (Line-type Lock Body) Lock body dimensions: 26*25*8mm Cable diameter: 1.8mm
BD-8003	Single-use Cable Seal Lock (Flat Lock Body) Lock body dimensions: 22*26*6mm Cable diameter: 2.0mm

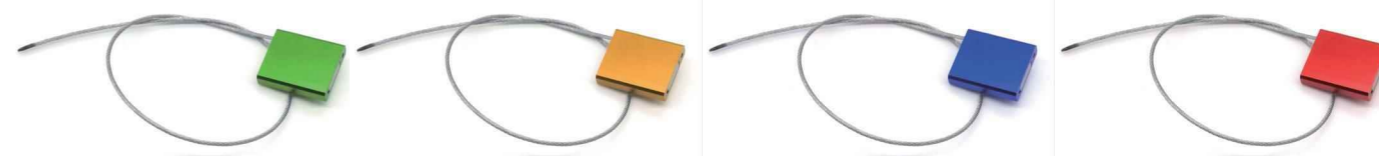

BD-8001



BD-8002



BD-8003